

INSIDE



Entertainment Guide

NEWS



Benefits forum for veterans page 5

NEWS



Las Cruces nominated for USDA deputy page 9

A&E



Cowboy Days coming page 21

Local news and entertainment since 1969

THE LAS CRUCES Bulletin

FRIDAY, FEBRUARY 24, 2023 | Volume 56, Number 8 | lascrucesbulletin.com



Active Aging section

Inside

Waging war against cancer



BULLETIN PHOTO BY ELVA K. ÖSTERREICH

Marci Dickerson turns her breast cancer experience around as she gets her head shaved during an event for Cancer Warriors of Las Cruces Feb. 20. At Buffalo Swag in Mesilla, makeup artist/hairstylist/entrepreneur/Cancer Warrior Ronna Carnathan cuts, clips and shaves as Dickerson announces the fundraising project by donating \$20,000 and challenging the community to donate. "The cancer journey sucks, and we want to make it suck less," Dickerson said. The group's goal is to provide advice, tips and functional items people need during their journey. This is the second Chemo Clips 4 a Cause event for the group. To participate or learn more, visit Facebook/Cancer Warriors of Las Cruces, or text Dickerson at 575-644-0778.

Choose Nusenda and earn great rewards!

Learn more at nusenda.org



Insured by NCUA | Equal Opportunity Lender | New members must qualify for membership.





CONTENT BROUGHT TO YOU BY:
YOUR PARTNER IN PROGRESS

CHAMBER'S JR. LEADERSHIP GETS UP CLOSE LOOK AT COUNTY OPERATIONS



On Feb 15, Doña Ana County hosted a Government Day tour for the Las Cruces Chamber of Commerce's Junior Leadership program. The high school juniors met with District 1 County Commissioner Christopher Schaljo-Hernandez, County Clerk Amanda López Askin, Ph.D. and Assistant County Manager Jonathan Macias. They also visited with the Doña Ana County Sheriff's Office Bomb Squad and learned how their work keeps the public safe. The visit was aimed to educate the students on the work of the County and inspire continued leadership and community involvement.



CONNECT WITH US:
WWW.DONAANACOUNTY.ORG

FOLLOW US ON SOCIAL MEDIA!



Hundreds to descend on LC for pecan conference

By **MIKE COOK**
Las Cruces Bulletin

The Western Pecan Growers Association's (WPGA) 57th annual conference, Sunday, March 5-Tuesday, March 7, in Las Cruces will include an educational program covering every aspect of the pecan industry, from shelling to selling.

Pecan experts from across the United States will discuss the current pecan market, irrigation, mechanical pruning, weather, two new pecan varieties, pecan research, pecan pests and more.

"This is a really good group of speakers," said New Mexico State University pecan specialist Richard Heerema, Ph.D., who coordinated the conference's educational

programming along with WPGA Director John White.

The conference keynote, "State of the Industry: The World is Going Nuts for Pecans," will be delivered by American Pecan Council President Alex Ott of Fort Worth to kick off the conference.

National Pecan Federation Chair Larry Don Womack of De Leon, Texas, and National Pecan Shellers Association Chair Steve Zaffarano of Atlanta, Georgia, will present "Advocating for Pecans."

University of Arizona Extension Meteorologist (emeritus) Paul Brown, Ph.D., will present "Consumptive Water Use of Pecans and Winter/Spring Weather Update."

Other presentations will include:

- "Insect Pests in the News," presented by state Entomologist Tiffany Johnson of the New Mexico Department of Agriculture in Las Cruces;

- "Finding Fungi: A Study on the Fungal Communities in Pecan Orchard Soils in the Southwestern U.S.," NMSU masters student McKenzie Stock;

- "How can we Manage Irrigation for the Benefit of Both Farm and Aquifer?" Sam Fernald, Ph.D., NMSU professor of watershed management and director of the New Mexico Water Resources Research Institute;

- "Comparison of Deep Percolation and Yield in Pecan Fields Under Different Irrigation Systems," NMSU Ph.D. student Jorge Preciado;

"A Changing Market

Environment: Potential Impacts for Pecans," Jay Lillywhite, Ph.D., assistant dean of economic and rural development at NMSU;

- "New USDA Pecan Variety Releases: 'Zuni', 'Pueblo' and 'Seneca,'" Xinwang Wang, Ph.D., pecan research geneticist with USDA pecan breeding and genetics, College Station, Texas. Heerema noted that two of the new varieties "are named after significant American tribes in the state of New Mexico." New pecan varieties "are really promising for the western region," he said.

- "Picturing Pecans: Detecting and Predicting Pecan Tree Characteristics," Warren Chatwin and Angelyn Hilton, both Ph.Ds. and pecan research geneticists at College Sta-



PHOTO COURTESY OF EMILY COATS PHOTOGRAPHY

Pecan growers from throughout the Southwest will be in Las Cruces March 5-7 for the Western Pecan Growers Association's annual convention.

tion, Texas.

The conference will also include the Pecan Food Fantasy contest, which has 16 categories with cash prizes of up to \$1,000 for the best pecan pie and other pecan recipes and is open to everyone. The WPGA banquet on Monday night will include an auc-

tion of the Food Fantasy contest prize-winning dishes, with proceeds benefiting the WPGA scholarship fund.

There also will be an exhibition of the pecan industry's latest innovative products and services, a trade show and a corn hole

SEE **NUTS**, PAGE 10

Certificate of Deposit Specials!

- Minimum to open \$1,000
- Must open or own an existing Century Bank personal or business checking account⁴
- Promotional rate cannot be combined with any other offers
- Personal accounts
- Business Accounts limited to \$200,000 maximum
- No public fund deposits
- Available for a limited time beginning February 3, 2023

NEW RATE

4.00%¹

Annual Percentage Yield² for 13 Months

OR

4.25%³

Annual Percentage Yield² for 25 Months

CENTURYBANK

MyCenturyBank.com | 505.995.1200



1. Upon Maturity, the CD will automatically renew as a 1 Year Classic CD at the current interest rate. **2.** APY assumes principal and interest remain on deposit for the term of the certificate and that interest is compounded annually and paid annually. Rates are subject to change without notice. APY is effective as of February 3, 2023. Minimum daily balance to earn APY is \$1,000. Fees may reduce the earnings on the account. Penalty for early withdrawal is equal to 360 days interest on the amount withdrawn. **3.** Upon Maturity, the CD will automatically renew as a 2 Year Classic CD at the current interest rate. **4.** Fees may be associated with a Century Bank checking account. Speak with a Century Bank representative for more information.

COMING UP

Friday, Feb. 24

- Book Sale, 10 a.m.-4 p.m., Roadrunner Room at Thomas Branigan Memorial Library, 200 E. Picacho Ave. Friends of the Library fundraising event. Info: 575-528-4000.
- Billy the Kid Festival: "The Trial of Billy the Kid," 7 p.m., Rio Grande Theatre, 211 N. Main St. Directed by Ross Marks, this play recreates the trial of the famous outlaw. Info: 575-541-2290.
- "Hookman," 7:30 p.m., AS-NMSU Center for the Arts, 1000 E. University Ave. Lexi tries to deal with looking for her best friend, a weird roommate, homesickness and a hook-handed serial killer.
- Live Music: Randy Granger, 7:30 p.m., Atkinson Recital Hall, NMSU. Creativity Week. Cost: Free. Info: 575-646-2421.
- "Matilda, the Musical," 7:30 p.m., Las Cruces Community Theatre, 313 Main St. Production based on the novel by Roald Dahl. Info: www.lcctnm.org.

Saturday, Feb. 25

- PACT Act Forum for veterans, 9 a.m.-1 p.m., Las Cruces Convention Center, 680 E. University Ave. Guest speaker from Albuquerque VA benefits office director. This forum is about new health care and other benefits for veterans. Info: 575-674-2602.
- Breast Cancer Support Group, 9:15 a.m., Memorial Medical Center Annex meeting room (entrance on the west side of the hospital). Info: 505-453-1789.
- Book Sale, 10 a.m.-4 p.m., Roadrunner Room at Thomas Branigan Memorial Library, 200 E. Picacho Ave. Friends of the Library fundraising event. Info:

575-528-4000.

- Engineering Expo, 10 a.m.-2 p.m., Las Cruces Railroad Museum, 351 N. Mesilla St. NASA, Atomic Aggies, Las Cruces and NMSU engineers on hand to share experiences and answer questions. Info: 575-528-3444.
- Story time at COAS Books, 10:30 a.m., 317 N. Main St. Info: 575-524-8471.
- Billy the Kid Festival movie: "Young Guns," 1 p.m., Rio Grande Theatre, 211 N. Main St., Las Cruces. A group of young gunmen, led by Billy the Kid. Info: 575-541-2290.
- Open House at Orthopedic Specialties, 2-4 p.m. 2467 S. Telshor Blvd. Info: 505-453-1789.
- "Confessions of an Editorial Cartoonist, 4-5 p.m., Doña Ana Arts Council, 230 S. Water St. Presented by Bob Diven. Cost \$10. Info: 575-523-6403.
- Billy the Kid Festival: "Sing the Legend," 7 p.m., Rio Grande Theatre, 211 N. Main St. A musical presentation with Crow and Karla and more. Info: 575-541-2290.
- "Hookman," 7:30 p.m. at the ASNMSU Center for the Arts, 1000 E. University Ave. Lexi tries to deal with looking for her best friend, a weird roommate, homesickness and a hook-handed serial killer.
- "Matilda, the Musical," 7:30 p.m., Las Cruces Community Theatre, 313 Main St. Info: www.lcctnm.org.

Sunday, Feb. 26

- Book Sale, 1-3 p.m., Roadrunner Room at Thomas Branigan Memorial Library, 200 E. Picacho Ave. Friends of the Library fundraising event fill a bag for \$5 day. Info: 575-528-4000.
- Billy the Kid Festival: "The Trial of Billy the Kid," 2 p.m., Rio

Grande Theatre, 211 N. Main St. Directed by Ross Marks, this play recreates the trial of the famous outlaw. Followed by a talk about Billy's actual murder trial with a historical perspective by David G. Thomas. Info: 575-541-2290.

- "Matilda, the Musical," 2 p.m., Las Cruces Community Theatre, 313 Main St. Info: www.lcctnm.org.
- Sunday Afternoon Dance, 2:30-4:30 p.m., 402 W. Court. A Dance Las Cruces event promoting ballroom, country, swing and Latin dancing. Info: Mike at 575-405-7403 or Ellen at 575-405-7403.

Monday, Feb. 27

- Black Health Fair, Black Programs Lounge, room 234, Corbett Center, NMSU. Info: 575-646-4208.
- Youth Cheer Registration begins, noon-8 p.m., Meerscheidt Recreation Center, 1600 E. Hadley Ave. Participants must be 5 years old by March 27. Info: 575-541-2563.
- Auditions for "Gypsy," 6-9 p.m., Las Cruces Community Theatre, 313 N. Main St. Auditioners should prepare a Broadway-style song. Info: 415-410-9509.

Tuesday, Feb. 28

- Children's Storytime, 11-11:30 a.m., Thomas Branigan Memorial Library Roadrunner Room, 200 E. Picacho Ave. Children 2-4 with their caregivers. Info: 575-528-4000.
- Auditions for "Gypsy," 6-9 p.m., Las Cruces Community Theatre, 313 N. Main St. Auditioners should prepare a Broadway-style son. Info: 415-410-9509.
- Beer and Bards, 7 p.m. on the side patio of the Spotted Dog Brewery, 2920 Avenida de Mesilla. Public readings of folk tales from the Six Celtic Nations. Info: 575-520-1916.

Wednesday, March 1

- Wednesday Storytime, 10 a.m., Barnes & Noble, Mesilla Valley Mall, 700 S. Telshor Blvd. # 1390. Info: 575-522-4499.
- Wednesday Lenten Worship, 6-7 p.m., Peace Lutheran Church, 1701 E. Missouri Ave., "Turning Toward God to Care for Our Common Home." For members and the community at large, a weekly contemplative look at climate change through a spiritual lens. Wednesdays during Lent. Info: 575-522-7119.

Friday, March 3

- "The Brave Little Tailor," 7 p.m., Rio Grande Theatre, 211 N. Main St. A Children's Theatre of the Mesilla Valley production. Cost: 12. Info: 575-571-1413.
- "Hookman," 7:30 p.m., AS-NMSU Center for the Arts, 1000 E. University Ave. Lexi tries to deal with looking for her best friend, a weird roommate, homesickness and a hook-handed serial killer.

Saturday March 4

- Rio Grande Planes N' Coffee, 9-11 a.m., Las Cruces International Airport, 8990 Zia Blvd. Info: 575-541-2471.
- Story time at Coas Books, 10:30 a.m., 317 N. Main St. Info: 575-524-8471.
- Barnyard Buddies Petting Zoo, 1-4 p.m., Tractor Supply Co. parking lot, 1440 W. Picacho Ave.

Cost: \$3. Info: 575-800-9200.

- "The Brave Little Tailor," 7 p.m., Rio Grande Theatre, 211 N. Main St. A Children's Theatre of the Mesilla Valley production. Cost: 12. Info: 575-571-1413.
- "Hookman," 7:30 p.m., AS-NMSU Center for the Arts, 1000 E. University Ave. Lexi tries to deal with looking for her best friend, a weird roommate, homesickness and a hook-handed serial killer.

Sunday, March 5

- Pecan Food Fantasy competition, 8-noon delivery, Las Cruces Convention Center, 680 E. University Ave. Multiple prizes and cash awards presented. Info: 575-652-6716.
- "Hookman," 2 p.m., ASNMSU Center for the Arts, 1000 E. University Ave. Info: 575-646-4515 or theatre.nmsu.edu.



It takes a local business owner to protect one.

Mike Apodaca, Agent
1100 South Main
Las Cruces, NM 88005
Bus: 575-526-2409
mike.apodaca.b9s4@statefarm.com

As a small business owner in our community, I understand what it takes to protect *your* small business. Let me help you get insurance for your business at a great value. Stop in or give me a call.



State Farm Fire and Casualty Company, State Farm General Insurance Company, Bloomington, IL
State Farm Florida Insurance Company, Winter Haven, Florida
State Farm Lloyds, Richardson, TX

1706444



Animal Services Center

OF THE MESILLA VALLEY



Delilah: 1 Year, Female (S)



I am sleek, elegant, and overall, the best kitty ever! I love being chatty and telling you stories and asking you for love and pets! All I want is my forever home with humans that I can love and cherish forever, I promise I'm the sweetest companion that you could ever adopt!

To foster or adopt, call 382-0018 or visit ascmv.org

AD SPONSORED BY Second Chance Thrift Store/APA
2475 N. Main • 575-888-4882



Know the signs

Do you know how to identify a natural gas leak? You might smell sulfur or rotten eggs, you may notice dirt or debris shooting up out of a hole in the ground, dead or dying vegetation in an otherwise green area, and a loud hissing or roaring sound near pipeline markers. These and many more are all tell tale signs of a natural gas or pipeline leak. Use all your senses, even common sense and report any possible leaks to Zia Natural Gas Company. When in doubt call us out!

As always, Zia personnel are available 24/7 for all natural gas emergencies. Call (575) 526-4GAS (4427) if you have a natural gas emergency.



ZIA NATURAL GAS COMPANY

New Mexico's Natural Choice

575-526-4427 | 1-800-453-5546

3700 W. Picacho Ave • Las Cruces

www.zngc.com



DACC

NMSU Doña Ana Community College

Local | Affordable | Accredited | Online

dacc.nmsu.edu | 575-527-7710

Feb. 25 forum offers vital benefits info to veterans

BULLETIN REPORT

The Las Cruces Vet Center, the VFW New Mexico Foundation and VFW Post #6917 will host a PACT (Honoring our Promise to Address Comprehensive Toxics) Act forum about new health care and other benefits for veterans, 9 a.m.-1 p.m. Saturday, Feb. 25, at the Las Cruces Con-

vention Center, 680 E. University Ave., the vet center said in a news release.

The event will provide veterans, their families, caregivers and survivors important information about the PACT Act and encourage them to apply for toxic exposure-related health care and benefits they have earned, the

news release said.

Albuquerque VA Regional Benefits Office Director Cesar Romero will be one of the speakers. Local VA staff will be on site to help veterans apply for benefits, complete toxic exposure screenings and enroll in VA health care in compliance with the PACT Act of 2022, a

new law that expands VA health care and benefits for veterans exposed to burn pits and other toxic substances, the news release said.

To help expedite and complete claims, attendees should bring the following documents, if available: medical records/medical evidence (doctor

or hospital reports), any documents that provide historical or military information needed for the disability being claimed, discharge or separation papers (DD 214 or equivalent and dependents' records (marriage certificate, death certificate, child's birth certificates)). Spouses/widows may be eligible for dependency and indemnity compensation when a veteran dies because of a presumptive disability, the vet center said.

"Because these conditions have already taken a serious toll on so many Veterans and their families, we are considering all conditions established in the PACT Act to be presumptive on Aug. 10, 2022, the date the bill was

signed into law," Romero said.

The PACT Act expands and extends eligibility for VA health care for veterans with toxic exposures and veterans of the Vietnam, Gulf War and post-9/11 eras; adds more than 20 new presumptive conditions for burn pits and other toxic exposures; adds more presumptive-exposure locations for Agent Orange and radiation; Requires the U.S. Veterans Administration to provide a toxic exposure screening to every veteran enrolled in VA health care; and helps the VA improve research, staff education and treatment related to toxic exposures. Visit www.va.gov/resources/the-pact-act-and-your-va-benefits/.



Children's Reading Alliance
575-522-3713
www.childrensreadingalliance.org

In March First Teacher/Primer Maestro™ classes will be offered at Dona Ana Elementary and Mesilla Park Elementary. Register now!

3880 FOOTHILLS RD., LAS CRUCES NM 88011



**DID YOU KNOW
WE OFFER
COSMETIC
Services**

- Botox®
- Dysport®
- Fillers
- CoolSculpting®
- Laser Treatments
- Microneedling
- HydraFacial®
- Chemical Peels
- European Facial
- Eyebrow & Eyelash Tinting

BOOK AN APPOINTMENT

(575) 521-1177

141 N Roadrunner Pkwy Ste 228
Las Cruces, NM 88011

WWW.EPIPHANYDERMATOLOGY.COM

Welcomes

John Reynolds, MD

Internal Medicine Specialist

Board Certified in

- Diabetes
- Metabolism
- Endocrinology

Now Seeing Patients!

575-528-6400

575 S. Alameda Blvd., Las Cruces, NM 88005

www.lcdfnm.org

THE LAS CRUCES
Bulletin

1740-A Calle de Mercado,
Las Cruces NM 88005

PHONE: 575-524-8061
FAX: 575-526-4621

www.lascrucesbulletin.com
editor@lascrucesbulletin.com

EDITOR & PUBLISHER
Richard Coltharp

**SALES MANAGER &
GENERAL MANAGER**
Jamila Khalil

SENIOR ACCOUNTANT
Jonathan Hudson-Edrosa

DISTRIBUTION
Becky Jimenez

ADVERTISING
Michael Alderete
Eve Holguin
Zachary Simmons
Matthew Torres

LEGALS/CLASSIFIEDS/OBITS
Maggie A. Adams
Becky Jimenez

NEWS
Elva Österreich, Special Projects
Christy Anchondo, Special Sections
Mike Cook, Lead Reporter

DISTRIBUTION: The Las Cruces Bulletin is complimentary at many locations in Las Cruces, limited to one copy per reader. We also have several vending machines in the area, where copies may be purchased for 75 cents.

SUBSCRIPTIONS: If you would like to receive the Bulletin at your home, a subscription is \$58 per year for local home delivery, or \$125 per year through the U.S. Postal Service.

COPYRIGHT: The entire contents of the Las Cruces Bulletin are copyright 2022 by the Las Cruces Bulletin.

Submit letters to editor@lascrucesbulletin.com or by fax at 575-526-4621. Letters should not exceed 350 words, may be edited for length or content and must include the writer's name, address and phone number for verification. Anonymous letters will not be published.

Aging gracefully, actively ... or at least trying

As I was driving around town last week, Pink Floyd's "Time" came on my truck's radio.

A specific line jumped out: "The sun is the same in a relative way, but you're older, shorter of breath and one day closer to death."

The line is literally true. Whether you're 9 or 99, you're a day closer to death today than you were yesterday. But instead of being depressed by the line, I was inspired and energized.

Sure, we're all going to die eventually, but isn't that all the more reason to start living and living your best life?

Things going on in our vibrant community supported my optimistic view.

In this week's Bulletin, you'll



RICHARD COLTHARP
From the Publisher

find a center section called Active Aging, which has a lot of good information to help us all age better.

For a story in the section, I had the good fortune of interviewing Hannah Cole and some of the dancers at her SOL Ballroom. The

dancers are of all ages and abilities, but each of them found a healing power in dance, and it was reflected in the smiles on their faces.

On our front page, you've got the irrepressible Marci Dickerson, one of a group of Cancer Warriors for Las Cruces, who have decided to turn the pain and struggle of their cancer journeys into something that can help others.

Starting soon in Doña Ana

County are the Senior Games. We had a program in our Feb. 10 edition, listing all the different events and opportunities for people 50 and older. It's a great way to hold yourself accountable to your exercise, but also, according to everyone I've talked with regarding the Senior Games, it's also an important social exercise, a place where people have made friends for life.

Of course, you don't have to be part of something organized to stay young at heart. My colleague Christy Anchondo has a small bumper sticker on her vehicle that says simply, "Beat Yesterday." Christy is an avid bicyclist and runner, but she's not trying to set any world records. She's following the advice from her Garmin watch, which tracks her exercise, to try and do better than yesterday's time.

Also in this week's Bulletin is a piece about Families & Youth Innovations Plus, the LC3 Behavioral Health Collaborative and Apple, working with people in the community to create a mental health app. There's been an increased focus in our society on mental health awareness, probably something that's overdue. This app could help people work on their own mental health.

Every week in our publication, we have information on events that are great things to get you out and get you active. Whether it's going to an Aggie softball game, attending a local play or concert, or just browsing at the library, gallery or museum, doing things either by yourself or with others can help make that one day closer to death better than yesterday.

Legislature considers waiting period for guns

Change at the New Mexico Legislature usually comes in small steps taken over a long period of time. That's especially true with gun laws.

The last significant changes came in 2019 with a bill to expand background checks and 2020 with one to allow the courts to file an emergency order temporarily taking guns from those proven to be at risk to themselves or others.

This year, I had high hopes for House Bill 101, which would ban assault rifles and high-capacity magazines. It cleared its first committee fairly early in the process, with a change that would allow current gun owners to keep their weapons.

But it seems that bill may be a step too far this year.

During a recent interview on KTAL-LP community radio, Miranda Viscoli of New Mexicans For the Prevention of Gun

Violence expressed both support for the bill and doubt that it will make it through this year. And so, their focus is on other bills.

One of them is Senate Bill 427 sponsored by Sen. Joseph Cervantes, D-Las Cruces, who is chairman of the Senate Judiciary Committee. It would require a 14-day waiting period after the initiation of the federal background check before a gun could be transferred.

"That's a game-changer in terms of suicide prevention and homicide prevention," Viscoli said, noting that many suicides are impulsive and that 59 percent of all gun deaths in New Mexico are by people taking their own lives.

Nine states now require waiting periods, including conserva-

tive Florida, which was moved to act following the Parkland school shooting in 2018, back when the American public still had some capacity for shock and horror.

A 2017 study published in the National Library of Medicine found that waiting periods reduce homicide rates by an average of 17 percent. But the larger impact is on suicide rates.

Oftentimes, suicide attempts are cries for help. Those who attempt to take their lives by other methods have a much better chance of having those cries heard than those with access to a gun.

Another effective way to reduce both suicides and accidental shootings is to require proper gun storage. We don't have a law covering that, but House Bill 9



WALT RUBEL
The View From Here

would at least hold gun owners responsible if their weapon was used by a minor in a way that would threaten or endanger others. It narrowly passed the House and is now in the Senate.

Opponents argued that keeping guns out of the hands of toddlers would put domestic violence victims in grave danger. And so, you can understand why the prospects for passing an assault weapons ban this session are bleak.

Walter Rubel is a freelance journalist based in Las Cruces. His 40-plus-year career includes work in Colorado, Wyoming, Kansas and—since 2002—in New Mexico, covering Las Cruces and the state Legislature. His opinions are his own and do not necessarily reflect the views of the Las Cruces Bulletin. Rubel can be reached at waltrubel@gmail.com.

At 114, NAACP's legacy of battling injustice continues

The National Association for the Advancement of Colored People (NAACP) was founded on Feb. 12, 1909, as a direct result of the outrage sparked by lynchings and other egregious acts of injustice. Now, 114 years later, the NAACP has 2,200 units nationwide, and more than two million members.

The players are different now, but the battle continues. The founders of the NAACP have long since passed on, but the torch has been handed down through generations. It wasn't always legal for Black folks to read and write. Even now, books that simply tell the story of Black history are being banned throughout the country.



GREEN

Nonetheless, there is hope. The descendants of slaves are now the educated leaders of the most powerful civil rights organization in this country, at the national, state and local levels. As the president of the local NAACP, I am keenly aware of my obligation to organize when it becomes necessary, to speak up when

Students are being shielded from reading about Black history at school, yet they are not protected from the threat of gun violence and mass killings at those same schools. We have work to do.

circumstances demand it, and to educate both inside the classroom and outside the classroom. The legacy I inherited from those who came before me dictates I must fulfill this obligation.

My lived experiences are such that I cannot ignore the systemic injustice happening at the national level or when it hits closer to home. The minority-serving university in my own backyard has historically been a revolving door for marginalized Black faculty, staff and students. Black students have been historically underrepresented, underfunded and underserved. That is part of our local Black history too.

So, I look to the legislative actions that have historically helped secure political, educational, social, and economic equality in the past. This has worked before. It will work again. So, I have no choice but to seek meaningful changes and improve the conditions for students in my own backyard. That is the least I can do.

BOBBIE GREEN, PH.D.
PRESIDENT, NAACP
DOÑA ANA COUNTY BRANCH

Bobbie Green has been interim director of New Mexico State University's Black Programs since September 2022.

How could civic engagement strengthen community safety?

The League of Women Voters, a nonpartisan organization, encourages citizens to be civically engaged in their communities. Every community has problems, some being common throughout our state and nation. These problems include lack of affordable housing, health care, food security and safety. To solve the problems, government, businesses, nonprofits and academic institutions need to work together. But individuals can also contribute by volunteering with civic organizations and using their voices to help find solutions and to encourage others to do the same. That is authentic civic engagement.

We all want to feel safe in our homes, work and communities. The League supports safety practices for law enforcement officers and the communities they serve. It also supports policies for law enforcement that build public trust and positive collaborative relationships through engagement with community members. One form of engagement could involve an independent community oversight committee as a vehicle for sharing information about policing issues and increasing the flow of information to the public.

Several Las Cruces citizens have developed a proposed ordinance for a Civilian Police Oversight Board, which

they want the city council to consider. But oversight agencies are not always effective and may even exacerbate tensions among local officials, law enforcement, and activists. They need to be empowered with appropriate tools and they require collaboration among other government and community efforts. This would include ongoing training for members of the oversight committee and for police officers.

We know that police officers have a challenging job protecting residents of a community and they generally serve us well. Law enforcement agencies have begun to make changes to improve their services. In Las Cruces, the police department now provides racial bias training and prohibits the use of chokeholds and other types of excessive force.

Seeking external review of complaints about the police, the City of Las Cruces contracted in March 2021 with the California-based OIR Group to provide audit reports of completed Las Cruces Police Department (LCPD) internal affairs complaints. The third audit report is scheduled to be presented at the City Council meeting Monday, Feb. 27. These reports provide the council and members of the public with information about the handling of police matters. Previous re-

ports are linked on the Council's website. OIR reported in August that the LCPD had responded favorably to feedback provided by the auditor. For example, LCPD is collecting more complete information about the demographics of those involved in incidents and about the outcomes of complaints. The LCPD is also expanding its review process concerning the use of force.

Is this type of external review sufficient? Or could an independent community oversight committee partner with law enforcement to increase safety and improve quality of life for all residents? How, specifically, would an effective committee be designed in our community?

The community's voice is essential for solving local problems. Community oversight focused on safety is one example of civic engagement with one complex problem. The League encourages individuals to become more civically engaged with issues of importance to them.

KATHY BROOK
EILEEN VANWIE
CO-PRESIDENTS
LEAGUE OF WOMEN VOTERS
OF SOUTHERN NEW MEXICO

Welcoming New Patients!

Vanessa Santana, FNP

FAMILY CARE AND PEDIATRICS
179 Howard Place
Las Cruces, NM 88011
575-521-8500



We accept Medicare, Medicaid, Tricare, Centennial Care and most private insurances.

New Mexico Primary Care Group, P.C.

THE EMPORIUM
Antiques, Collectibles, Furniture, Jewelry, Gifts

Furniture Donations Always Welcome!

DONATE SHOP SUPPORT

Mesilla Valley Hospice
106 S. Water St. • 575-523-8078 • emporiumlc.com
Tues-Fri 10am-4pm, Sat 10am-2pm

SHOP TOUCAN!

FREE!
3 lb. bag of onions
One per person. Excludes all other discounts.
With \$25 Purchase
EXPIRES 3/3/23

LOCAL PRODUCTS · GREAT CUSTOMER SERVICE
UNIQUE FOODS · QUALITY PRODUCTS

1701 #1 E. UNIVERSITY AVE. • 521.3003

WEEKEND BREAKFAST IS BACK!

SATURDAY & SUNDAY, 8:30 AM-11 AM
COFFEE & JUICE INCLUDED

STARTING SATURDAY, **Feb. 18!**

golden corral

Enjoy endless helpings of over **50 breakfast favorites** like made-to-order omelets, carved ham, pancakes, waffles, assorted sweets, and fresh fruit, plus all the classic breakfast essentials!

Available only at the Las Cruces, NM Golden Corral starting Saturday, February 18.

TAKE THE QUIZ FOR A CHANCE TO WIN

TWO VIP TICKETS to the

LAS CRUCES INTERNATIONAL FILM FESTIVAL APRIL 12-16 2023

Special Guests include 2023 honoree, Giancarlo Esposito! Tickets include entry for all film screenings, and panels PLUS the private VIP party with the celebrities.

Contest ends on April 5, 2023
Brought to you by the Las Cruces International Film Festival and the Las Cruces Bulletin.

BUY TICKETS NOW! WWW.LASCRCESFILMFEST.COM

WITH SPECIAL GUESTS

GIANCARLO ESPOSITO ANNA GUNN CHRISTOPHER MCDONALD WILLIAM MOSELEY KEVIN REYNOLDS

ENTER TO WIN HERE

lascrucbulletin.secondstreetapp.com/Las-Cruces-International-Film-Festival-Ticket-Giveaway-2023

SHIFT & SAVE!

Want an easy way to reduce your electric bill?

El Paso Electric's **Time-Of-Day** Program can help, offering rates nearly **4 times lower** by shifting your energy use to evenings.

This program is ideal for you if you can:

- Pre-cool your home early and turn off AC during the day
- Reduce daytime appliance use
- Do dishes and laundry in the evening

Plus, **it's risk-free!** If you don't see savings after one year, El Paso Electric will credit your account.

Join our Time-Of-Day Program today and start seeing the benefits for yourself. Get started at epelectric.com/TOD or scan here now.

El Paso Electric

f t i y i d u

Torres Small nominated as USDA deputy secretary

BULLETIN REPORT

President Jo Biden has nominated former U.S. Rep. Xochitl Torres Small of Las Cruces as deputy secretary of the United States Department of Agriculture.

The Feb. 15 nomination “reflects the Biden-Harris administration’s commitment to rural prosperity, advancing equity and making USDA the best place to work,” said USDA Sec. Tom Vilsack.

Torres Small was confirmed by the U.S. Senate as USDA undersecretary for rural development in

October 2021.

If again confirmed by the U.S. Senate, Torres Small will replace Jewel H. Bronaugh as second in command at USDA.

“I’m honored to be considered for the role of deputy secretary for USDA,” Torres Small told the Bulletin. “From growing up in New Mexico, to representing my home in Congress, to serving as undersecretary for rural development, I’ve seen the hard work in rural America that supports our nation. That’s why rural people deserve every opportunity

to thrive in the places they call home. If confirmed, I look forward to continuing to chart a course to deliver on the Biden-Harris administration’s historic investments in rural America, to drive investments in the next generation of workforce, and to ensure USDA is well-equipped to best serve the American people, now and into the future.”

Torres Small was elected to the U.S. House of Representatives in November



TORRES SMALL

2018 to represent New Mexico’s Second Congressional District. She lost reelection in 2020.

“The granddaughter of farmworkers, Torres Small grew up in the borderlands of New Mexico. She has worked as a Field Representative for Sen. Tom Udall, D-N.M., clerked for U.S. District Court Judge Robert C. Brack and served as an attorney practicing water and natural resources law,” the White House said in a news release about Torres Small’s nomination to be deputy

secretary.

Torres Small is married to New Mexico State Rep. Nathan Small of Las Cruces. A graduate of the University of New Mexico School of Law, Torres Small “became the first woman and first person of color to represent New Mexico’s second congressional district,” the news release said.

“Throughout her career, Torres Small has put her experience to use in the name of making lasting investments in the people, institutions and infrastructure essential for tribal

nations and communities throughout the rural U.S. to thrive,” Vilsack said. “Her expertise will further USDA’s mission to advance equity and opportunity in and for rural America, and USDA’s commitment to build an organization invested in the success of its workforce and the customers we serve.”

“Congratulations to my friend Xochitl Torres Small on her nomination as USDA deputy secretary,” said U.S. Ben Ray Lujan, D-N.M., who served with Torres Small in the U.S. House of Representatives.

Go Ahead!



Go Nuts!



Karin Davidson
**Pecan
Food Fantasy
Competition**



**REGISTER FOR
CONTEST HERE!**



**Registration Deadline:
March 3, 2023 @ 11:59**

YOUTH AND ADULT CATEGORIES!

CATEGORIES

Quick Breads • Yeast Breads

Candy • Cheesecake

Cookies: Drop, Bar & Other

Cakes: Iced and Un-Iced

Decorated Cupcakes

Traditional Pecan Pie • Other Pies

Tarts • Sugar Free / Keto • Savory

Gluten Free Baked Goods

See Website for Quantity Rules

MARCH 5, 2023

PRIZES/AWARDS

First Prize in all categories **\$40**

Best adult & youth traditional

pecan pie is awarded **\$250**

Outstanding adult **\$200**

Outstanding youth **\$100**

Best of Show **\$250**

Presented at banquet

See website for more details

All entries must be delivered to the Las Cruces Convention Center on Sunday, March 5, 2023 between 8am and 12 noon.

All entries must be handmade by the participant and MUST CONTAIN PECANS. Entries become property of the WPGA.

Questions? Call Jenni Kosnick Hart at 575-652-6716



ADVANCED CARE HOSPITAL
OF SOUTHERN NEW MEXICO



“Words are insufficient to express the gratitude that Bob and I feel for all the tender, loving care that I received during my stay.” - Helen

- Comprehensive Rehabilitation Program
- Ventilator Weaning Program
- And more. For more information, visit

ACHSNM.ERNESTHEALTH.COM

4451 East Lohman Avenue • Las Cruces, NM 88011
ph: 575.521.6600 • fax: 575.532.5077

We Are Hiring

• Utility Accountant

The position is responsible for all utility accounting functions and including gas volume reporting, regulatory compliance, and annual reporting.

• Human Resources Manager

The position is responsible for all human resource functions for Natural Gas Processing including payroll, benefits management, and hiring and retaining employees.

To apply, please send a resume with cover letter to:

Oscar Saucedo at
osaucedo@zngc.com

Drop off at
100 Short Dr,
Ruidoso Downs, NM

Or mail to
Zia Natural Gas Co.
Attn: Oscar Saucedo,
PO Box 888,
Ruidoso Downs, 88346



ZIA NATURAL GAS COMPANY



For the **LOVE** of Art series
every Saturday in February
February 25th
3 pm - 5 pm

Our Finale in the Meet the Artist Series

Dina D'Argo

With bold brushstrokes, lush colors, and textural elements, Dina D'Argo captures the grace and beauty of her natural subjects. Her focus is on celebrating the bond between ourselves and nature.

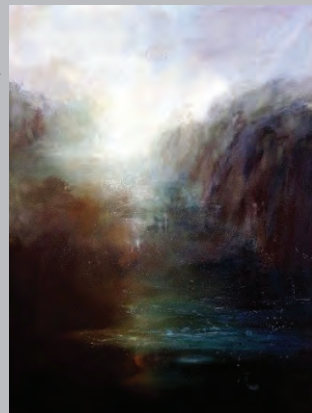

Rio Grande
Fine Art

Gallery located at 382 S Walnut
inside Picture Frame Outlet

PICTURE FRAME
OUTLET
and GALLERY

NUTS

CONTINUED FROM 3

tournament.

Heerema will moderate a growers panel on the mechanical pruning of pecan trees, which will feature four pecan producers from across the Southwest discussing all the ways they trim trees to maximize pecan production.

White said a vendor presentation program has been added to this year's conference, allowing vendors to talk about the products and services available to pecan growers across the country.

WPGA will honor long-time board members Mike

Kilby, who is retired from the Arizona Cooperative Extension Service and has attended more than 50 WPGA conferences, and Art Ivey of Tornillo, Texas, whose grandfather was instrumental in the creation of WPGA.

WPGA, founded in 1971, is based in Mesilla Park. The nonprofit represents pecan growers in California, Arizona, New Mexico and West Texas.

New Mexico is second only to Georgia in commercial pecan production. Doña Ana County produces 70 percent of New Mexico's pecan crop and is the largest pecan-producing county in the U.S.

NMSU has become a repository for pecan seeds and trees from the region where pecans grow naturally, which stretches from central Mexico to northern Illinois, including parts of eastern Texas and Oklahoma.

The conference will be held at Las Cruces Convention Center, 680 W. University Ave. About 600 people are expected to attend.

Online registration (www.westernpecan.org) closes Feb. 23. Registration at the door will be available at an increased cost.

Contact WPGA Director John White at 575-640-7555 (text) and directorwesternpecan@gmail.com.

LAS CRUCES UTILITIES

TO: NATURAL GAS CUSTOMERS
Los clientes que utilizan los Servicios de Gas Natural



Maintenance of Customer Owned Gas Piping

Notice: In accordance with Congressional Mandate (Docket PS-135, Amendment 192-3), the City of Las Cruces Gas Section hereby notifies you that the portion of gas piping (yard line) between the gas meter and the house/building is not maintained by the Gas Utility Company. Please see drawing.

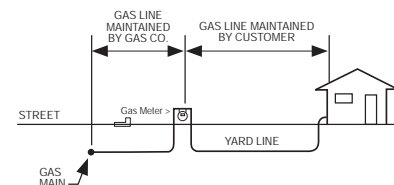

Please keep in mind that:

- Buried steel gas piping that is not maintained may be subject to the potential hazards of corrosion and subsequent gas leakage.
- Buried gas piping should be:
 - Periodically inspected for leaks.
 - Periodically inspected for corrosion if the piping is metallic.
 - Repaired if unsafe condition is found.
- Before excavating near buried gas piping, the piping should be located, marked, and excavated by hand.
- Licensed gas fitters/plumbers and contractors can assist in performing the required inspections described in (2) above, making leak repairs, and locating the buried gas piping prior to the start of any planned excavation.

STATEMENT
Therefore,
if you have
gas piping
as described,
it is your
responsibility
to safely
maintain it.

Mantenimiento para clientes que son dueños de las tuberías de Gas

Aviso: De acuerdo con el mandato del congreso (Archivo PS - 135, Enmienda 192-3), el Departamento de Gas de La Ciudad de Las Cruces por medio de esta notificación le hace saber a usted que su porción de tubería de gas (yarda lineal) que se encuentra entre el medidor de gas y la casa/edificio no recibe mantenimiento por la compañía de Gas. Por favor vea el dibujo.

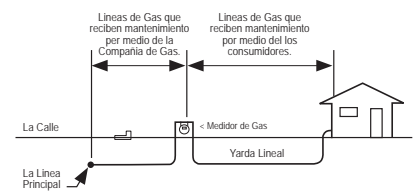

Por favor tenga en mente que:

- Tubería de acero enterrada que no se le da mantenimiento está sujeta a peligros potenciales de corrosión y subsecuentemente a fugas de gas.
- La tubería de gas enterrada debe de ser:
 - Inspeccionada periódicamente para detectar fugas de gas.
 - Inspeccionada periódicamente para detectar corrosión si la tubería es metálica.
 - Reparada si se encuentra alguna condición peligrosa.
- Antes de excavar cerca de la tubería de gas enterrada, la tubería debe de ser localizada, marcada, y la excavación debe de ser hecha manualmente.
- Montadores de gas, plomeros, y contratistas con licencia pueden asistir haciendo las inspecciones requeridas como se describe en el número (2) arriba, haciendo las reparaciones de las fugas, y localizando la tubería de gas enterradas antes de empezar cualquier plan de excavación.

Declaración:
Por lo tanto,
si usted tiene
tubería de
gas como se
describe, es
su responsabilidad de
mantenerla
segura.

Dispatch EMERGENCIES: (575) 526-0500
Call Before You Dig - New Mexico One Call: 811
Gas Section, City of Las Cruces: (575) 528-3505



CUSTOMER SERVICE: (575) 541-2111
City Hall, 700 N. Main St., Las Cruces, NM 88001

05/2018B

City seeks to address high pedestrian fatality rate

By MIKE COOK
Las Cruces Bulletin

Per capita, New Mexico has the highest rate of pedestrian fatalities of any state, according to the U.S. Department of Transportation (USDOT), and the rate for Las Cruces – which averaged nine pedestrian fatalities a year from 2011 to 20 – is 60 percent above the national average.

Those were among the statistics reported to the Las Cruces City Council during its Feb. 13 work session on pedestrian safety.

“Safety is a community goal,” said Trung Vo of Toole Design, a transportation planning and design company with offices in 18 cities in the United States and Canada.

Vo, the director of Toole’s Denver office, and currently contracted with the City of Las Cruces to provide consulting services related to traffic safety.

“People make mistakes,” Vo told council members via Zoom, but those mistakes do not have to result in death or serious injury. “Deaths are preventable.”

The Safe System Approach (SSA) advocated by Toole and USDOT has five “complementary objectives:” safer people, safer roads, safer vehicles, safer speeds and post-crash care.

To reduce pedestrian deaths and injuries in Las Cruces, he said, the city should focus on its entire traffic system rather than just hot spots.

“We focus on safety for

everyone,” Vo said.

As an example, he said, nearly 90 percent of pedestrian fatalities in Las Cruces occurred on streets with speed limits of 35 miles per hour or higher. Streets can be designed or redesigned to prioritize lower speeds, especially where people are walking or bicycling, Vo said.

Street reconfigurations, which can be expensive and time consuming, can include only one lane going in each direction, a turn lane, bike lanes between the roadway and pedestrians and physically separating walkers and bikers from motorists, he said.

Short-term interventions include speed-safety cameras, traffic calming devices like speed cush-

ions and speed humps, improved crosswalk visibility, repairing broken streetlights, striped and paved street shoulders and sidewalk repair, Vo said.

City Traffic and Streets Administrator Soogyu Lee said street lighting is being studied in five areas of Las Cruces, and the city is also looking at five traffic corridors to find ways to make them safer.

Three of the corridors: El Paseo Road, Roadrunner Parkway and University Avenue, are city streets. The other two, north Main Street and Picacho Avenue, are state roads maintained by the New Mexico Department of Transportation (NMDOT), Lee said.

The city and NMDOT

must work together to identify traffic safety issues, plan and design ways to deal with them and find funding to implement changes, he said.

“Speed is an important factor,” said George Pearson, president of Velo Cruces, a nonprofit “seeking to make Las Cruces a more bike and pedestrian friendly community.” Reducing the default roadway speed limit from 30 to 25 miles per hour would make streets safer, Pearson said, and “would send the message that council is looking at this and raise some awareness.”

“One of the biggest causes of pedestrian congestion is schools,” said Ashleigh Curry, coordinator for Las Cruces Public Schools Safe Routes to Schools Program, one

of the most successful walking- and biking-to-school programs in the nation. “If we can make our streets for our kids to be able to walk and bike to school, we can reduce a lot of those conditions around the schools of traffic congestion,” said Curry, who is also a member of the NMDOT’s Pedestrian Safety Workforce.

“We are actively working on identifying the data, analyzing it and creating solutions,” said city Innovation and Strategic Manager Srijana Basnyat. “With better design and long-term thinking we can provide solutions to these problems.”

The city council is expected to look again at pedestrian safety during an April 10 work session.

Santa Teresa hosts Ambassador, U.S. Rep

BULLETIN REPORT

“International trade between the U.S. and Mexico is essential for economic growth and prosperity in both countries,” U.S. Rep. Gabe Vasquez, D-N.M., said during a Feb. 14 news conference in Santa Teresa, where he was joined by U.S. Ambassador to Mexico

Ken Salazar to discuss international trade at the border.

“Having lived on both sides of the border, I understand our border region is a vital economic gateway between the United States and Mexico, and Ambassador Salazar can tell you that, too,” Vasquez said.

“In fact, both my father and mother worked in the maquiladora industry, working to assemble parts for the aerospace industry and working to build the sensors in our refrigerators and our washing machines, right here in Ciudad Juarez. We must take the steps to ensure that trade, commerce continue to flow smoothly.

“As a proud fronterizo and member of Congress, I will educate my colleagues on the importance of this port of entry, the importance of building fruitful relationships with Mexico, and the need to foster international trade. Our shared vision for the border includes a vital economic gateway between the United States and Mex-

ico that is built on trust, respect, and mutual economic benefit,” Vasquez said.

“With the help of the New Mexico Border Authority, the Border Industrial Association (BIA), MVEDA (Mesilla Valley Economic Development Alliance) and the Borderplex, our local governments and strong federal partnerships, we can support initiatives that promote economic development on both sides of the border,” he said.

“It was good to have the Ambassador tour the Santa Teresa port facilities and have first-hand knowledge of our issues and needs,” said BIA President Jerry Pacheco of Santa Teresa, who attended the news conference.



PHOTO COURTESY JERRY PACHECO

U.S. Ambassador to Mexico Ken Salazar and U.S. Rep. Gabe Vasquez visited Santa Teresa Feb. 14.

Be my Valentine

BULLETIN REPORT

A total of 30 couples tied the knot on Valentine’s Day, Tuesday, Feb. 14, at the Doña Ana County Government Center, as the offices of County Clerk Amanda Lopez Askin and County Probate Judge Judith Ann Baca partnered to

perform the ceremonies.

“Being a part of the marriage ceremonies yesterday was a wonderful experience,” deputy clerk Caroline Zamora said. “The couples and families were incredibly appreciative of the service, and it was a complete joy.”



COURTESY PHOTO

Doña Ana County Deputy Clerk Brandi Delgado marries a couple at the county government center Feb. 14 for the annual “Romance in the Rotunda” event.

New NMSU provost has wide, varied background

ADRIANA M. CHÁVEZ
NMSU News Team

Alan R. Shoho, dean and professor emeritus of the School of Education at the University of Wisconsin-Milwaukee, has been named New Mexico State University's new provost and chief academic officer following a national search, NMSU Chancellor Dan Arvizu announced Feb. 20. Shoho begins his new role April 17.

"Dr. Shoho has tremendous experience both as an administrator and as a researcher in the fields of education and social justice," Arvizu said. "His vision for NMSU aligns with the progress we've made toward the goals outlined in our

LEADS 2025 strategic plan, and I am sure he is the best fit to help elevate our research and social mobility initiatives."

"The search committee for the provost and chief academic affairs officer did its due diligence, and worked very hard and in a very professional, cordial and dedicated manner. We are delighted that the hard work ended with the hiring of Dr. Alan Shoho. We stand ready to work with Dr. Shoho and assist him during the transition," said Rolando A. Flores Galarza, dean and chief



SHOHO

administrative officer for the NMSU College of Agricultural, Consumer and Environmental Sciences and chair of the provost search committee.

Before serving as dean at the University of Wisconsin-Milwaukee for five years, Shoho was associate vice provost for academic and faculty support at the University of Texas at San Antonio for two years. He started his academic career as an assistant professor in the University of Portland's School of Education in 1991. Previously, he worked as a high school math teacher in Hawaii after working as an electrical engineer for Hughes Aircraft Company and Rockwell International. Shoho's father, a

Korean War veteran who grew up on the island of Kauai in Hawaii as the seventh of 11 children, earned a degree in electrical engineering from the University of Illinois using the G.I. Bill.

"I have personally experienced how families are transformed with the opportunities created through access to higher education," Shoho said. "Had he not been able to attend and earn his degree in electrical engineering from the University of Illinois, my life would likely have been very different. Consequently, I am very passionate about providing students with the same opportunities."

Shoho said he was interested

in becoming NMSU's provost because of its status as a Hispanic-serving institution and a land-grant university, and because of the university's mission to improve student success and advance equity, inclusion and diversity.

"Improving student success is critical to NMSU's future, and similarly equity, inclusion and diversity is integral to creating a healthy culture, where NMSU can re-achieve its R1 status and address grand challenges like racism and generational poverty, and borderland, environmental, health and social issues, to improve the quality of life for all New Mexicans and beyond," Shoho said.

Schools' 'Data Jam' continues for Asombro Institute

BULLETIN REPORT

Desert Data Jam is underway at Asombro Institute for Science Education (AISE).

Hosted by the nonprofit AISE and the United States Department of Agriculture's Jornada Experimental Range and schools in southern New Mexico, the jam is continuing through April 25, with about 350 students and teachers participating from Vista, Sierra, Picacho and Zia middle schools and White Sands School, AISE Communications and Operations Coordinator Amy Tront said.

For the competition, students are provided with real datasets collected locally, AISE said. They "learn how to use data to answer questions and then design a creative project and presentation board about data trends.



Past creative projects have included children's books, songs, videos, physical models, infographics and games."

The top three projects from each participating class earn a place in a finals competition that will be held April 25-27 at New Mexico State University, with cash prizes (\$300 for first place, \$200 for second and \$100 for third) and other awards presented.

"Desert Data Jam is not like a science fair, students

will not be collecting data, instead they will be looking for data trends and communicating the data and trends through their presentation boards and creative projects," AISE said.

This year is the 12th jam, and the first one held in person in two years because of the pandemic.

The Asombro (the Spanish word for "wonder") Institute "is dedicated to increasing natural science literacy through engaging, place-based education," according to the AISE website. It provides thousands of children and adults with hands-on, inquiry-based science education programs each year in classrooms, schoolyards and the Chihuahuan Desert Nature Park north of Las Cruces.

AISE was incorporated as a nonprofit in 1990 as

the Las Cruces Nature Park. It was renamed Chihuahuan Desert Nature Park in 1997 and AISE in 2008.

Grant received

The New Mexico Public Education Department recently awarded AISE a New Mexico Outdoor Learning start-up grant to develop and launch a new "Schoolyard Field Trip" program, where Asombro will work with Las Cruces Public Schools to bring "a well-rounded, full-functioning, educational field trip experience to schools right in their own schoolyards," AISE said.

The program helps schools that have a hard time finding funds for field trips to still have a fun and educational field trip, AISE said. Contact Tront at 575-524-3334 and amy@asombro.org. Visitasombro.org/desert-data-jam.



COURTESY PHOTO

A bird's-eye view of a pre-Covid edition of Asombro Institute's Desert Data Jam competition.



Brought to you by
the Las Cruces Utilities
Water Conservation Program

2023 SPRING 1 SCHEDULE

MARCH 2, 2023

MAKING THE MOST OF YOUR LANDSCAPE DESIGN

Learn basic principals of landscape design and how to apply them to your own home landscape. **PRESENTED BY:** Rachel Gioannini, Assistant Professor of Horticulture, NMSU

MARCH 9, 2023

CoCoRaHS... WHAT'S THAT?

Focus on the Community Collaborative Rain Hail and Snow (CoCoRaHS) network as an example of a citizen science group. **PRESENTED BY:** Dr. Dave DuBois, New Mexico State Climatologist, NMSU

MARCH 16, 2023

FRUIT TREES FOR THE LAS CRUCES ENVIRONMENT

Review recommended fruit tree varieties and care tips to optimize tree health and fruit production. **PRESENTED BY:** Marisa Thompson, Ph.D., Extension Urban Horticulture Specialist, NMSU

MARCH 23, 2023

SOILS AND MULCHES

Learn how to prepare healthy soils to enhance landscape and water retention, and the benefits of organic mulches. **PRESENTED BY:** Dr. Bill Lindemann, Retired Soils Professor, NMSU

MARCH 30, 2023

PASSIVE RAINWATER HARVESTING

This workshop will provide design information of landscaping features that will protect water resources from the sky or across your property. **PRESENTED BY:** Michael Gaglio, High Desert Native Plants

All workshops will be held at the **Branigan Library**, Roadrunner Room, 200 E. Picacho, Las Cruces on **Thursdays from 5:30PM-7:30PM.**
Presentations begin promptly at 5:45PM.

ALL WORKSHOPS ARE FREE!

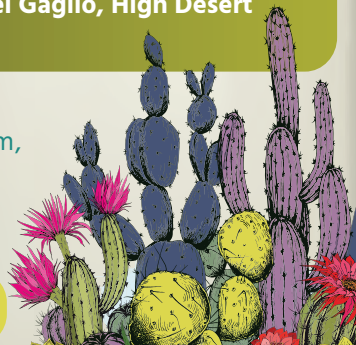

For more information call 575-528-3566 or visit www.lcutilities.org/waterconservation

Classifieds

Help Wanted Full-Time

NEW MEXICO STATE UNIVERSITY

Central Property Inventory Control Clerk (Staff) #198318 Requisition #2300087S NMSU is an equal opportunity and affirmative action employer. For further information and to apply online, visit our website <https://jobs.nmsu.edu/postings/49424>

a Casa, Inc. is seeking consulting firms to identify the current and future needs and gaps in services for survivors of domestic, family and dating violence in Doña Ana County. Contact La Casa, Inc. for the RFP at 575-526-2819 or visit www.lacasainc.org. Due 5:00pm March 6, 2023.

DACC, a responsive accessible learning-centered community college that provides education opportunities to a diverse community of learners is inviting candidates to apply for the following

vacant position:
Administrative Assistant Associate
Requisition #2300108S
Required Education: High School diploma or GED certificate.

Required Experience: One (1) years of experience related to the standard duties as outlined
Equivalency: Completion of a post-secondary degree or certificate may substitute for years of experience

Classification Summary Under direct supervision, performs a variety of administrative and staff support duties for a specified unit/department, which require a range of skills and a knowledge of organizational policies and procedures. Assists and directs visitors, and resolves administrative problems and inquiries; composes, edits, and proofreads correspondence and reports, and prepares a range of administrative documents. For a complete job announcement and to apply for position, please visit <https://jobs.nmsu.edu/postings/49494>
Deadline to apply for this position is 03/12/2023

We invite you to take the first step to a successful and rewarding career at <https://talent.nmsu.edu/> NMSU/DACC is an Equal Opportunity/Affirmative Action Employer

Residential Service Coordinator

All dreams come true! PRS-NM is accepting resumes for the Residential Service Coordinator position in Las Cruces, New Mexico. Come work with our Developmentally Disabled population. Preferred experience in Human Services with DD Waivers and good computer skills, but willing to train the right person. Send resumes to ehom@prs-nm.org or dnelson@prs-nm.org

Director of Operations PRS-NM is accepting resumes for Director of Operations in Las Cruces New Mexico. Bachelors Degree in Human Services preferred. Qualifications include experience in Management and DD Waiver Services. Send resumes to ehom@prs-nm.org or dnelson@prs-nm.org

Office Manager Settle into a daily routine, PRS-NM is accepting resumes for the Office Manager position in Las Cruces, New Mexico. Must have High School Diploma or GED equivalent. Preferred proficiency in MS Office (Excel, Word), but willing to train the right person. Send resumes to ehom@prs-nm.org or dnelson@prs-nm.org

NEW MEXICO STATE UNIVERSITY
Lab Tech, Research (Req 2300057S, Pos 199571) fulltime position within the Department of Biology. For specific position details and to apply online, please visit: <https://jobs.nmsu.edu/postings/49064>. NMSU is an equal opportunity and affirmative action employer

Miscellaneous

Applying for Social Security Disability or Appealing a Denied Claim? Call Bill Gordon & Assoc., Social Security Disability Attorneys, 1-855-380-6225! FREE Consultations. Local

Attorneys Nationwide [Mail: 2420 N St NW, Washington DC. Office: Broward Co. FL (TX/NM Bar.)

Viasat Satellite Internet. Up to 12 Mbps Plans Starting at \$30/month. Our Fastest Speeds (up to 50 Mbps) & Unlimited Data Plans Start at \$100/month. Call Viasat today! 1-855-260-8627

Wesley Financial Group, LLC Timeshare Cancellation Experts Over \$50,000,000 in timeshare debt and fees cancelled in 2019. Get free informational package and learn how to get rid of your timeshare! Free consultations. Over 450 positive reviews. Call 866-925-1156

High-Speed Internet. We instantly compare speed, pricing, availability to find the best service for your needs. Starting at \$39.99/month! Quickly compare offers from top providers. Call 1-877-737-6167

Vacation Properties: ADVERTISE YOUR VACATION PROPERTY to more than 185,000 New Mexico newspaper readers. Your 25-word classified ad will appear in 23 newspapers around the state for only \$158. Call this newspaper for more details or visit www.nmpress.org for more details.

BATHROOM RENOVATIONS. EASY, ONE DAY updates! We specialize in safe bathing. Grab bars, no slip flooring & seated showers. Call for a free in-home consultation: 505-515-0292

HughesNet Satellite Internet - 25Mbps starting at \$49.99/mo! Get More Data FREE Off-Peak Data. FAST download speeds. WiFi built in! FREE Standard Installation for lease customers! Limited Time, Call 1-855-800-2806

Cable Price Increase Again? Switch To DIRECTV & Save + get a \$100 visa gift card! Get More Channels For Less Money. Restrictions apply. Call Now! 877-891-7176

BANKRUPTCY RELIEF! Help stop Creditor

Mountain Music
2330 S. Valley Drive
523-0603
New & Used Musical Instruments

Ibanez G10 Electric Guitar.....	\$125
Ibanez EX Series Electric Guitar.....	\$200
Boulder Creek Bass Guitar.....	\$345
Fender "99" Mexico Strat 9V Tone Boost.....	\$550
Samick 3 Pickup Tele.....	\$
Jackson.....	\$
Jackson Dinky Reverse.....	\$
Cort Acoustic Bass Guitar.....	\$
Mapex Mars Series Drumset.....	\$600
Pair JBL 1x18 Front Loaded Sub PA.....	\$450
Hammond 1959 M3 Organ & 1x12 Speaker.....	\$500
1954 Harmony F-Hole Acoustic Guitar.....	\$300
1920s Maple Small Banjo/Mandolin.....	\$300
1959 Roth Full Size Violin.....	\$600
Roth 4/4 Violin.....	\$400
Buffet Cremona R13 Clarinet with Case.....	\$3500
Corn Director Trumpet.....	\$300
Mirage USA Flute with Case.....	\$150
15-Bar Autoharp with case.....	\$165
1925 Stella Oval Hole Mandolin.....	Let's Trade

Consignment Sales • Trade-In at 100 percent
Half-price String Sets Sat. & Sun. Each Week!
Visit us on and at reverb.com
M-F 10AM - 6PM
SATURDAY 10AM - 4PM
SUNDAY 10AM - 2PM

Classifieds

Harassment, Collection Calls, Repossession and Legal Actions! Speak to a Professional Attorney and Get the Help You NEED! Call NOW 833-954-0330

DIRECTV Stream - The Best of Live & On-Demand On All Your Favorite Screens. CHOICE Package, \$84.99/mo for 12 months. Stream on 20 devices in your home at once. HBO Max included for 3 mos (w/CHOICE Package or higher.) No annual contract, no hidden fees! Some restrictions apply. Call IVS 1-833-937-0271

Two great new offers from AT&T Wireless! Ask how to get the new iPhone 11 or Next Generation Samsung Galaxy S10e ON US with AT&T's Buy one, Give one offer. While supplies last! CALL 1-888-989-2198

4G LTE Home Internet Now Available! Get GotW3 with lightning fast speeds plus take your service with you when you travel! As low as \$109.99/mo! 855-407-7829

EXPIRES SOON: Switch to DISH + get a 2 YEAR PRICE LOCK!! Plus get Free Premium Channels for 3 mos. Free Installation (up to 6 rooms)! 844-937-3775

DIAGNOSED WITH LUNG CANCER? You may qualify for a substantial cash award - even with smoking history. NO obligation! We've recovered millions. Let us help!!! Call 24/7, 866-411-0726

Don't let the stairs limit your mobility! Discover the ideal solution for anyone who struggles on the stairs, is concerned about a fall or wants to regain access to their entire home. Call AmeriGlide today! 1-844-366-9951

Put on your TV Ears and hear TV with unmatched clarity. TV Ears Original were originally \$129.95 - NOW WITH THIS SPECIAL OFFER are only \$59.95 with code MCB59! Call 1-888-549-0182

DONATE YOUR CAR FOR KIDS! Fast Free Pickup - Running or Not - 24 Hour Response -

Maximum Tax Donation - Help Find Missing Children. Call Now 877-925-0934

Great new offer from AT&T Wireless! Ask how to get the new iPhone 12 mini for as low as \$0 with trade in. While supplies last! CALL 1-866-516-0099

DONATE YOUR CAR OR TRUCK TO HERITAGE FOR THE BLIND. Free 3 Day Vacation, Tax Deductible, Free Towing, All Paperwork Taken Care Of. CALL 1-877-613-0103

Become a Published Author. We want to Read Your Book! Dorrance Publishing-Trusted by Authors Since 1920 Book manuscript submissions currently being reviewed. Comprehensive Services: Consultation, Production, Promotion and Distribution Call for Your Free Author's Guide 1-833-549-7564 or visit dorranceinfo.com/nmpa

DIRECTV for \$79.99/mo for 12 months with CHOICE Package. Watch your favorite live sports, news & entertainment anywhere. First 3 months of HBO Max, Cinemax, Showtime, Starz and Epix included! Directv is #1 in Customer Satisfaction (JD Power & Assoc.) Some restrictions apply. Call 1-888-758-5998

BATH & SHOWER UPDATES in as little as ONE DAY! Affordable prices - No payments for 18 months! Lifetime warranty & professional installs. Senior & Military Discounts available. Call: 877-378-3613

Don't Pay For Covered Home Repairs Again! American Residential Warranty covers ALL MAJOR SYSTEMS AND APPLIANCES. 30 DAY RISK FREE/ \$100 OFF POPULAR PLANS. 833-660-1335

LONG DISTANCE MOVING: Call today for a FREE QUOTE from America's Most Trusted Interstate Movers. Let us take the stress out of moving! Speak to a Relocation Specialist, call 877-621-0331

Get DIRECTV for \$64.99/mo for 12 months with CHOICE

Package. Save an additional \$120 over 1st year. First 3 months of HBO Max, Cinemax, Showtime, Starz and Epix included! Directv is #1 in Customer Satisfaction (JD Power & Assoc.) Some restrictions apply. Call 1-888-758-5998

Caring for an aging loved one? Wondering about options like senior-living communities and in-home care? Caring.com's Family Advisors are here to help take the guesswork out of senior care for you and your family. Call for your FREE, no-obligation consultation: 1-888-694-7553

FREE high speed internet for those that qualify. Government program for recipients of select programs incl. Medicaid, SNAP, Housing Assistance, WIC, Veterans Pension, Survivor Benefits, Lifeline, Tribal. 15 GB internet service. Bonus offer: Android tablet FREE with one-time \$20 copay. Free shipping & handling. Call Maxisp Telecom today! 1-888-960-1792

Switch and save up to \$250/year on your talk, text and data. No contract and no hidden fees. Unlimited talk and text with flexible data plans. Premium nationwide coverage. 100% U.S. based customer service. Limited time offer - get \$50 off on any new account. Use code GIFT50. For more information, call 1-833-651-2183

DISH Network. \$64.99 for 190 Channels! Blazing Fast Internet, \$19.99/mo. (where available.) Switch & Get a FREE \$100 Visa Gift Card. FREE Voice Remote. FREE HD DVR. FREE Streaming on ALL Devices. Call today! 1-855-404-4306

The Generac PWRcell, a solar plus battery storage system. SAVE money, reduce your reliance on the grid, prepare for power outages and power your home. Full installation services available. \$0 Down Financing Option. Request a FREE, no obligation, quote today. Call 1-844-928-2078

Attention Viagra users: Generic 100 mg blue pills or Generic 20 mg

yellow pills. Get 45 plus 5 free \$99 + S/H. Guaranteed, no prescription necessary. Call 855-762-0571

Legal Notice

NOTICE is hereby given that on January 11, 2023, Jacobo R. Carver, P.O. Box 159, Mesilla Park, NM 88047, filed with the **STATE ENGINEER** Application No. LRG-16722-POD3, OSE File No. LRG-16722-1, for Permit to Change Point of Diversion within the Lower Rio Grande Underground Water Basin of the State of New Mexico by discontinuing use of well LRG-16722-POD1, located on land owned by applicant, within the NE¼ of Section 15, Township 24 South, Range 02 East (NMPM), and more specifically described where Latitude and Longitude intersect at 32° 13'29.508" N and 106° 43'9.229" W (WGS84), and drill replacement well LRG-16722-POD3, to be located within 100 feet of existing well in Section 15, Township 24 South, Range 02 East (NMPM), and more specifically described where Latitude and Longitude intersect at 32° 13'29.492" N and 106° 46'9.375" W (WGS84). Replacement well LRG-16722-POD3 will be supplemental to well LRG-16722-POD2, specifically described where Latitude and Longitude intersect at 32° 13'28.208" N and 106° 43' 10.896" W (WGS84), on land owned by applicant, for the continued diversion of water not to exceed 3.0 acre-feet per annum, as described by Subfile Order No. LRS-28-004-1005-A of the Third Judicial District Court, Dona County, State of

LEGAL NOTICES

New Mexico. The site of replacement well LRG-16722-POD3 can further be located at the physical address of 915 FoIt Fillmore Rd. approximately 0.85 miles West from the intersection of S. Main Street and Fort Fillmore Road. The applicant has requested emergency authorization to drill the proposed well under NMSA, 1978, Section 72-12-22. Dona Ana is the County affected by the diversion and in which the water has been or will be put to beneficial use. This notice is ordered to be published in the Las Cruces Bulletin. To view the application and supporting documentation contact the State Engineer District Office to arrange a date and time for an appointment located at 1680 Hickory Loop, Suite J, Las Cruces, NM 88005. Any person, firm or corporation or other entity asserting standing to file objections or protests shall do so in writing (objection must be legible, signed, and include the writer's complete name, phone number, email

address, and mailing address). If the protest does not include the complete name, phone number, email address, and mailing address, it may be deemed invalid and not accepted for filing unless Protestant provides with the protest an affidavit stating that it does not have one of the above-listed elements (phone number, mailing address, email address, etc.). The objection to the approval of the application must be based on: (1) Impairment; if impairment, you must specifically identify your water rights; and/or (2) Public Welfare/Conservation of Water; if public welfare or conservation of water within the state of New Mexico, you must show how you will be substantially and specifically affected. The written protest must be filed, in triplicate, with the State Engineer, 1680 Hickory Loop, Suite J, Las Cruces, NM 88005 on or before **April 7, 2023**. Facsimiles (faxes) will be accepted as a valid protest if the hard copy is hand-delivered or mailed and

postmarked within 24-hours of the facsimile. Mailing postmark will be used to validate the 24-hour period. Protests can be faxed to the Office of the State Engineer, at 575-524-6160. If no valid protest or objection is filed, the State Engineer will evaluate the application in accordance with the provisions of Chapter 72 NMSA 1978

Dates: 02/10, 02/17, 02/24, 2023

STATE OF NEW MEXICO COUNTY OF DONA ANA THIRD JUDICIAL DISTRICT COURT

Case No.: D-307-CV-2022-02302 MORTGAGE ASSETS MANAGEMENT, LLC, Plaintiff, vs. HAROLD C DEPP; UNITED STATES OF AMERICA BY AND THROUGH THE SECRETARY OF HOUSING AND URBAN DEVELOPMENT; BARCLAYS BANK DELAWARE, Defendants.

NOTICE OF PENDENCY OF ACTION
STATE OF NEW MEXICO to Defendant, Harold C Depp, to be pub-

lished on: You are hereby notified that the above-named Plaintiff Mortgage Assets Management, LLC has filed a civil action against you in the above-entitled Court and cause, the general object thereof being to foreclose a mortgage on real property located at 5201 Seminole Trail, Las Cruces, NM 88012. The real property which is the subject matter of this action is legally described as follows: LOT NUMBERED 36P IN BLOCK NUMBERED 11 OF ELEPHANT BUTTE LAND & TRUST CO. SUBDIVISION "C" AMENDMENT NO. ONE OF PART OF BLOCK ELEVEN, DONA ANA COUNTY, NEW MEXICO, AS THE SAME IS SHOWN AND DESIGNATED ON THE PLAT OF SAID ELEPHANT BUTTE LAND & TRUST CO. SUBDIVISION "C" AMENDMENT NO. ONE OF PART OF BLOCK ELEVEN, FILED IN THE OFFICE OF THE COUNTY CLERK OF DONA ANA COUNTY, NEW MEXICO ON JUNE 6, 1996 IN PLAT BOOK 9, FOLIO 97.

PUBLIC NOTICE		NOTICIA PÚBLICA	
<p>The Mesilla Valley Public Housing Authority (MVPHA) is pleased to announce the opening of the waitlist for the Section 8 Project - Jardines Verdes for: 1 and 2-bedroom units. The waitlist will open on February 21, 2023, until further notice. To apply, please visit our website at www.MVPHA.org, on the home screen, select "Waitlist Openings" category and select the link.</p>		<p>La Autoridad de Vivienda de Mesilla Valley (MVPHA) se complace en anunciar la apertura de la lista de espera para el Proyecto de Sección 8 - Jardines Verdes para: 1 y 2-recamaras. La lista de espera se abrirá el 21 de febrero de 2023, hasta nuevo aviso. Para aplicar, visite nuestro sitio web en www.MVPHA.org, en la pantalla de inicio, seleccione la categoría "Aperturas de lista de espera" y seleccione el enlace.</p>	
<p>The waitlist is only for elderly or disabled individuals/families.</p>		<p>La lista de espera es solamente para individuos o familias que sean ancianos o discapacitados.</p>	
<p>If you or a family member is a person with a disability and require a reasonable accommodation to apply, please contact our office at (575) 528-2000. Or you may apply in person Monday through Thursday, from 8:00 am to 3:30 PM at 926 S. San Pedro Street, Las Cruces, NM 88001.</p>		<p>Si usted o un miembro de la familia es una persona con discapacidad y requiere una adaptación razonable para aplicar, comuníquese con nuestra oficina al (575) 528-2000. O puede aplicar en persona de lunes a jueves, de 8:00 a.m. a 3:30 p.m. en el 926 Sur de la Calle San Pedro, Las Cruces, NM 88001.</p>	
<p>Individuals/Families will be selected in order by date and time of the application submission.</p>		<p>Los individuos/familias serán seleccionadas en orden por fecha y hora del envío de la solicitud.</p>	
<p>Appropriate unit bedroom size for a family / tabla para determinar el tamaño adecuado de recamaras de la unidad para una familia:</p>			
# of Bedrooms / # de recamaras	# of Persons / # de personas	Minimum / Mínimo	Maximum / Máximo
1 BR	1	1	2
2 BR	2	2	4
<p>926 S. San Pedro, Las Cruces, NM 88001 • (575) 528-2000 VOICE • (575) 526-9541 FAX • TDD/TTY/711</p>			

THE LAS CRUCES Bulletin

Your **WEEKLY GUIDE TO TV & ENTERTAINMENT**

February 24 - March 2, 2023

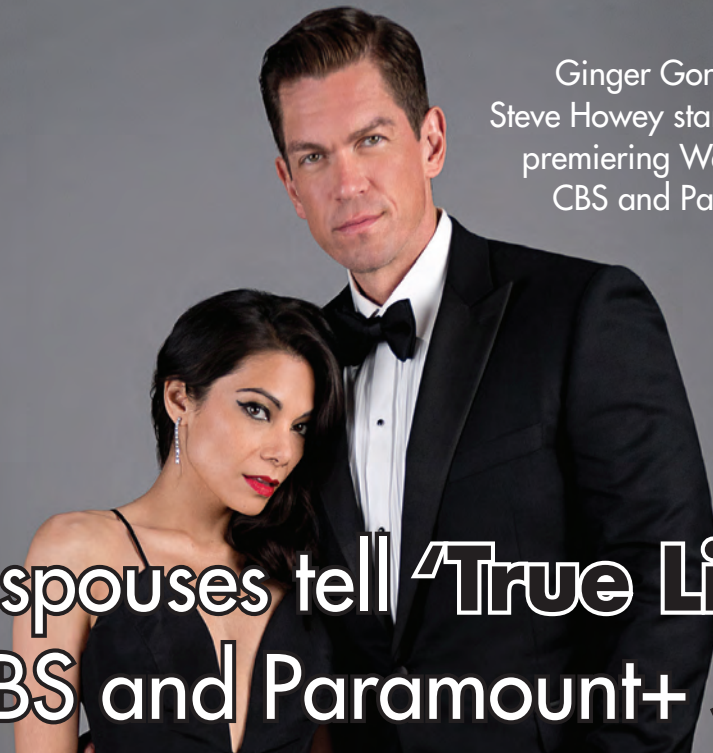

Ginger Gonzaga and Steve Howey star in "True Lies," premiering Wednesday on CBS and Paramount+.

Spying spouses tell 'True Lies' in new CBS and Paramount+ series

Las Cruces Transportation



YOUR RIDE. YOUR WAY.

**Las Cruces Shuttle - Taxi
Charter - Courier**

**VETERAN OWNED
7 DAYS A WEEK SINCE 1985**



**Call us to make
a reservation today!**

We are Covid-19 Safe-Practice Compliant

Call us at 800-288-1784
or for more details
visit www.lascrucesshuttle.com

CLEARIMAGINGLLC.NET



575-259-3069

4440 N Sonoma Ranch Blvd, Suite G, Las Cruces, NM 88011

WE WORK AROUND YOUR SCHEDULE



DEXA

STANDING OPEN MRI

X-RAY

DEXA

DUAL-ENERGY ABSORPTIOMETRY GOLD STANDARD TECHNOLOGY
LEAN MASS FAT MASS VISCERAL FAT SKELETAL HEALTH
98% ACCURATE ESTABLISH A BASELINE
GET A COMPREHENSIVE REPORT WITH NO GUESSING

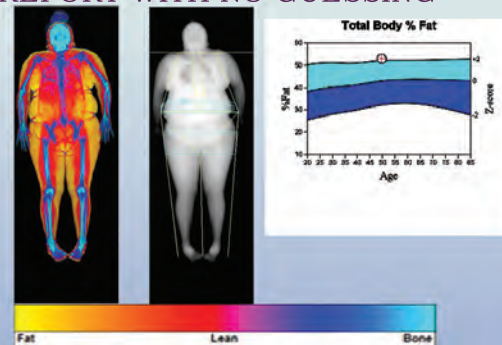
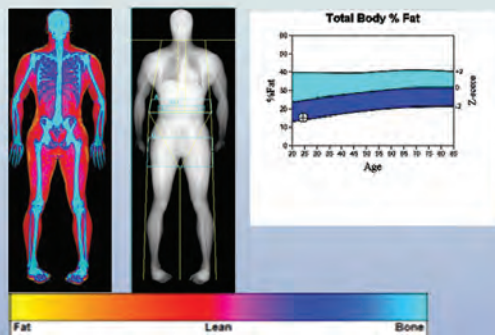

Our DEXA not only offers bone density services, but includes whole body scans that quantify the total pounds (lbs.) of fat throughout your entire body, segregating it from lean muscle mass and bone mineral content (BMC), including a breakdown into primary body parts.

*Always at
your fingertips!*



**No login.
No fees.**

Check out the entire
Bulletin in our
weekly e-edition.

THE LAS CRUCES
Bulletin

www.lascrucesbulletin.com

What's Available NOW On **hulu**

Attract All the Birds for Under \$18

The all-in-one feeder that attracts them all with seed, suet, nuts and fruit.

- Great for First Time Bird Feeders
- Great Additions to Your Existing Setup

Flying Start* Combo

FREE

Feeder (\$9 Value) with purchase of 3 Stackables* for \$17.97

* Valid only at the store listed below. Offer not valid on previous purchases; one per person.

2001 E Lohman, Suite 130, Las Cruces, NM 88001
(575) 523-5489 • www.wbu.com/lascruces
BIRD FOOD • FEEDERS • GARDEN ACCENTS • UNIQUE GIFTS

“Movie: The Storied Life of A.J. Fikry”

Kunal Nayyar (“The Big Bang Theory”) has the title role in this 2022 comedy about a man whose wife has died, his bookstore is failing and his rare edition of Poe poems was stolen, who gets a new lease on life when a mysterious package shows up at his doorstep. Christina Hendricks, Lucy Hale and Scott Foley are also in the cast. (ORIGINAL)



“Movie: A Million Little Pieces”

James Frey’s memoir of the same name formed the basis for this 2018 drama that stars Aaron Taylor-Johnson (“Nocturnal Animals”) as Frey, a drug-addled writer who one day wakes up with no memory of the last few weeks and consequently checks himself into a rehab center, where he meets an array of interesting characters. Billy Bob Thornton and Charlie Hunnam also star.



“Movie: The Forsaken”

From Spain comes this 2015 horror tale about a group of criminals who kidnap a wealthy businessman’s daughter and must spend the night awaiting the ransom in an abandoned house, where each come face to face with their own darkest fears. Ian Breeds, Alberto Esparza and Pol Ferraris head the cast for director Yolanda Torres (“The Anarchist’s Dream”).



“Movie: The Book Thief”

A youngster in World War II-era Germany is the title character in this acclaimed 2013 drama from director Brian Percival (“Downton Abbey”) that stars Sophie Nélisse as a girl who shares books she’s stolen with the Jewish refugee (Ben Schnetzer) being sheltered by her foster parents (Geoffrey Rush, Emily Watson).



FRIDAY EVENING

S - Spectrum D - Dish DTV - DirecTV

MOVIES

SPORTS

SPECIALS

FEBRUARY 24, 2023

	S	D	DTV	6 PM	6:30	7 PM	7:30	8 PM	8:30	9 PM	9:30	10 PM	10:30	11 PM	11:30	12 AM	12:30	
PBS-KRWG	2	22	22	NewsHour	BBC World	Wash	Firing-Hoover	Great Performances (N)			Magic Moments -- The Best of '50s Pop (My Music)			Revisiting the 1950s.		PBS NewsHour		
CBS-KDBC	3	4	4	Jeopardy! (N)	Wheel	S.W.A.T. "Gut Punch" (N)	Fire Country "Bad Guy"			Fire Country		CBS4 News	Late Show-Colbert	James Corden		Identity Theft		
ABC-KVIA	7	7	7	News	Ent. Tonight	The Mandalorian			20/20			News	(:35) Jimmy Kimmel Live!	(:37) Nightline	Ent. Tonight	Hollywood		
FOX-KFOX	8	14	14	Big Bang	Big Bang	WWE Friday Night SmackDown (N Same-day Tape)			KFOX News at Nine (N)			Mod Fam	iCRIME	Two Men		Two Men		
NBC-KTSM	9	9	9	KTSM News	Studio 9	Lopez vs	Young Rock	Dateline NBC (N)			KTSM News			Tonight Show-J. Fallon	Late Night With Seth Meyers		(:37) TMZ (N)	
UNI-KINT	10	-	26	La rosa de Guadalupe (N)	Perdona nuestros pecados			Mi camino es amarte (N)			Cabo "Todo en contra" (N)		Noticiero Uni.	Noticiero	Contacto deportivo (N) (Live)		Mi camino es amarte	
TEL-KTDO	11	48	48	La casa de los famosos (N)			El señor de los cielos (N)			Amor y traición (N)		Noticiero	Noticias	Zona mixta	Caso cerrado	Enemigo íntimo		
UMAS-KTFN	13	7593	65	¡Siéntese quien pueda! (N)			(6:58) Enamorándonos (N) (Live)			Resistiré (N)		Faisy Nights (N)	¡Siéntese quien pueda!			Resistiré		
CW-KVIA2	14	17	8	Sheldon	Sheldon	Penn & Teller: Fool Us		Whose Line	Whose Line	Seinfeld	Seinfeld	Sheldon	Neighbor	Last-Standing	25 Words	Pawn Stars	Storage Wars	
A&E	43	118	265	The First 48 "Blood Feud"		The First 48		(:01) The First 48 "Tracked"		(:04) The First 48		(:03) The First 48		(:03) The First 48		(12:04) The First 48		
AMC	57	131	254	*** "The Hunger Games: Mockingjay, Part 1" (2014) Josh Hutcherson			*** "The Hunger Games: Mockingjay, Part 2" (2015) Jennifer Lawrence.						Mayfair Witches "Tessa"		Hunger			
COMEDY	35	107	249	The Office	The Office	The Office	The Office	The Office (:45) The Office			The Office	The Office	The Office	The Office	The Office	Kevin Hart: Laugh		
COOK	123	113	232	Iron Chef America		Iron Chef America		Iron Chef America			Iron Chef America		Iron Chef America		Iron Chef America			
DSC	47	182	278	Gold Rush "Trial by Parker" Tony's crew faces a flood. (N)			Aussie Gold Hunters			Aussie Gold Hunters		Gold Rush "Trial by Parker" Tony's crew faces a flood.						
E!	37	114	236	** "Men in Black 3" (2012, Action) Will Smith, Tommy Lee Jones.			*** "Men in Black" (1997, Action) Tommy Lee Jones.			** "Men in Black II" (2002, Action) Tommy Lee Jones.			MIB 3					
ESPN	27	140	206	(5:30) NBA Basketball Miami Heat at Milwaukee Bucks.			NBA Basketball Brooklyn Nets at Chicago Bulls. (Live)			(3:5) SportsCenter (N) (Live)			SportsCenter (N) (Live)		SportsCenter			
FOOD	40	110	231	Diners, Drive	Diners, Drive	Diners, Drive	Diners, Drive	Diners, Drive	Diners, Drive	Diners, Drive	Diners, Drive	Diners, Drive	Diners, Drive	Diners, Drive	Diners, Drive	Diners, Drive	Diners, Drive	
FX	29	136	248	*** "The Avengers" (2012, Action) Robert Downey Jr., Chris Evans, Mark Ruffalo.			The Mandalorian			** "The Hangover Part II" (2011, Comedy) Bradley Cooper, Ed Helms.			Hangover II					
GALA	25	273	404	Una familia de diez (N)		Nosotros los guapos (N)		Vecinos (N)			40 y 20	40 y 20	Renta	Renta	Alma de	Alma de	Simón dice	Simón dice
GOLF	24	401	218	(5:00) PGA Tour Golf The Honda Classic, Second Round.			LPGA Tour Golf Honda LPGA Thailand, Third Round. (Live)											
HALL	58	185	312	"A Cozy Christmas Inn" (2022, Romance) Jodie Sweetin.			The Way Home			Golden Girls		Golden Girls	Golden Girls	Golden Girls	Golden Girls	Frasier	Frasier	
HGTV	41	112	229	Dream Home	Dream Home	Dream Home	Dream Home	Hunters	Hunters	Dream Home	Dream Home	Dream Home	Dream Home	Hunters	Hunters	Dream Home	Dream Home	
HISTORY	44	120	269	Ancient Aliens			Ancient Aliens (N)			(:03) Ancient Aliens		(:05) Ancient Aliens		(:03) Ancient Aliens		(:05) Ancient Aliens		
LIFE	39	108	252	"Newlywed Nightmare" (2023) Yoshi Sudarso. Premiere.			(:03) ** "Kidnap" (2017) Halle Berry, Sage Correa.			(:01) "Newlywed Nightmare" (2023) Yoshi Sudarso.			(12:04) ** "Kidnap" (2017)					
LIFEMOV	119	109	253	** "The Hitman's Bodyguard" (2017, Action) Ryan Reynolds.			"Stalked by My Doctor" (2015, Suspense)			(:01) ** "The Hitman's Bodyguard" (2017, Action) Ryan Reynolds.			Stalked					
NBATV	273	156	216	(5:00) NBA GameTime			NBA GameTime			NBA Game			NBA Game		NBA Game			
PAR	34	241	241	** "Fifty Shades of Grey" (2015) Dakota Johnson, Jamie Dornan.			(:35) ** "Fifty Shades Darker" (2017, Romance) Dakota Johnson, Jamie Dornan.			(:25) * "Fifty Shades Freed" (2018)								
SYFY	59	122	244	(5:00) *** "Back to the Future Part II"			*** "Back to the Future" (1985) Michael J. Fox, Christopher Lloyd.			The Ark		Charmed "Sin Francisco"		Charmed				
TBS	33	139	247	** "Captain Marvel" (2019, Action) Brie Larson, Samuel L. Jackson.			(:28) *** "Captain America: Civil War" (2016, Action) Chris Evans, Robert Downey Jr.			(:28) *** "Blades of Glory" (2007)								
TCM	169	132	256	*** "The Naked Spur" (1953, Western)			(:45) ** "Day of the Outlaw" (1959) Robert Ryan.			**** "The Wild Bunch" (1969) William Holden, Ernest Borgnine.			"Plan 9 From Outer Space"					
TLC	45	183	280	90 Day Fiancé: The Other Way With bonus scenes. (N)			90 Day: Other Darcey & Stacey			90 Day: Other 90 Day Fiancé: The Other Way With bonus scenes.			90 Day: Other Darcey					
TNT	32	138	245	(5:00) *** "Furious 7" (2015) Vin Diesel. Premiere.			All Elite Wrestling: Rampage			*** "Furious 7" (2015, Action) Vin Diesel, Paul Walker, Dwayne Johnson.			** "Fast & Furious"					
TRAV	49	196	277	Kindred Spirits			Kindred Spirits (N)			Kindred Spirits		Kindred Spirits		Kindred Spirits				
TRU TV	30	242	246	Inside Jokes			Inside Jokes			** "Horrible Bosses" (2011, Comedy) Jason Bateman.			** "Horrible Bosses" (2011, Comedy) Jason Bateman.					
USA	31	105	242	(5:30) 9-1-1		9-1-1 "Boston"		9-1-1 "FOMO"		9-1-1 "May Day"		9-1-1 "Hero Complex"		9-1-1 "Starting Over"		Chrisley	Dateline	

SATURDAY EVENING

S - Spectrum D - Dish DTV - DirecTV

MOVIES

SPORTS

SPECIALS

FEBRUARY 25, 2023

	S	D	DTV	6 PM	6:30	7 PM	7:30	8 PM	8:30	9 PM	9:30	10 PM	10:30	11 PM	11:30	12 AM	12:30
PBS-KRWG	2	22	22	Your Legisla	Weekend	Daniel O'Donnell From Castlebar, Ireland			Taking Chances World Tour - The Concert			John Sebastian's Folk Rewind (My Music Presents)			Your Legisla	Weekend	
CBS-KDBC	3	4	4	Jeopardy!	Wheel	54th Annual NAACP Image Awards (N Same-day Tape)			48 Hours			CBS4 News	Reporter	Spotlight on	(:32) The National Desk (N)	In Touch	
ABC-KVIA	7	7	7	NBA	NBA Basketball	Boston Celtics at Philadelphia 76ers. (Live)			Amer. Athlete	Sports Stars	ABC 7 at 10	(:35) Access Hollywood (N)	WOW - Women Of Wrestling			Kickin' It	
FOX-KFOX	8	14	14	(5:30) College Basketball	Indiana at Purdue.	Hoops	Big Bang	Big Bang	News	Bensinger	Special Forces-Toughest	Two Men	Two Men	Family Guy	Family Guy		
NBC-KTSM	9	9	9	KTSM News	Around	The Wall	Saturday Night Live (N)			KTSM News	(:29) Saturday Night Live (N) (Live)	Laughs	Saturday Night Live				
UNI-KINT	10	-	26	Fútbol Mexicano	Primera División	Fútbol Mexicano Primera División Atlas vs. América. (Live)			Nosotros los.	Noticiero Uni	Me caigo de risa Galilea juega con la familia. (N)						
TEL-KTDO	11	48	48	** "Ride Along 2" (2016, Comedia)	Ice Cube, Kevin Hart.	**** "Rocky" (1976) Sylvester Stallone, Talia Shire.			Noticias T	Zona mixta	Decisiones	Decisiones	Programa	Programa			
UMAS-KTFN	13	7593	65	"Assassination Games" (2011)	Jean-Claude Van Damme.	* "Everly" (2014) Salma Hayek, Hiroyuki Watanabe. (N)			Programa	Programa	"Assassination Games" (2011) Jean-Claude Van Damme.						
CW-KVIA2	14	17	8	Housewife	Housewife	Masters of	Masters of	Animals	Animals	Neighbor	black-ish	S.W.A.T. "The Fugitive"	The First 48	Comedy.TV			
A&E	43	118	265	** "Jack Reacher" (2012, Action)	Tom Cruise, Rosamund Pike, Robert Duvall.	(:04) WWE Rivals			(:03) ** "Jack Reacher" (2012, Action)	Tom Cruise, Rosamund Pike, Robert Duvall.							
AMC	57	131	254	(:15) ** "Uncle Buck" (1989, Comedy)	John Candy, Amy Madigan.	** "National Lampoon's European Vacation" (1985)			** "Major League" (1989, Comedy) Tom Berenger, Charlie Sheen.								
COMEDY	35	107	249	Seinfeld	Seinfeld	Seinfeld	Seinfeld	Seinfeld	Seinfeld	54th Annual NAACP Image Awards (N)			** "Get Hard" (2015, Comedy) Will Ferrell, Kevin Hart.				
COOK	123	113	232	Spring Baking Championship	"Molly's Mardi Gras"	Spring Baking Championship			Spring Baking Championship	Spring Baking Championship	Spring Baking Championship			"Molly's Mardi Gras"	Spring Baking Championship		
DSC	47	182	278	Homestead Rescue	The Raneys rescue a young family.	(:01) Homestead Rescue			A family survives in a dome home.	Homestead Rescue			The Raneys rescue a young family.	(:12:01) Homestead Rescue			
E!	37	114	236	(4:30) "It's Complicated"	** "This Means War" (2012, Action)	Reese Witherspoon.	** "Legally Blonde" (2001)			Reese Witherspoon.	** "Legally Blonde" (2001) Reese Witherspoon.						
ESPN	27	140	206	College Basketball	Virginia Tech at Duke. (Live)	College Basketball			Saint Mary's at Gonzaga. (Live)	SportsCenter (N) (Live)			SportsCenter (N) (Live)			SportsCenter (N) (Live)	
FOOD	40	110	231	Diners, Drive	Diners, Drive	Diners, Drive	Diners, Drive	Diners, Drive	Diners, Drive	Diners, Drive	Diners, Drive	Diners, Drive	Diners, Drive	Diners, Drive	Diners, Drive	Diners, Drive	Diners, Drive
FX	29	136	248	(5:00) XFL Football	D.C. Defenders at Vegas Vipers. (Live)	*** "Iron Man" (2008, Action)			Robert Downey Jr., Terrence Howard, Gwyneth Paltrow.	*** "Ant-Man and The Wasp" (2018) Paul Rudd.							
GALA	25	273	404	Me caigo de risa	La historia de unas máquinas rebeldes.	Faisy Nights (N)	& noche (N)			XH Derbez	Programa Programa Proteja su Programa						
GOLF	24	401	218	(5:00) PGA Tour Golf	The Honda Classic, Third Round.	LPGA Tour Golf			Honda LPGA Thailand, Third Round. (Live)								
HALL	58	185	312	"Made for Each Other" (2023)	Alexandra Turshen.	(:01) "Sweet Autumn" (2020, Romance)			Nikki DeLoach.	Golden Girls	Golden Girls	Golden Girls	Golden Girls	Golden Girls	Golden Girls	Golden Girls	
HGTV	41	112	229	Holmes Family Rescue (N)	Rico to the Rescue (N)	House Hunters			Hunters	Hunters Int'l	Rico to the Rescue			House Hunters	Hunters	Hunters Int'l	
HISTORY	44	120	269	The UnXplained	(:02) The UnXplained	(:05) The UnXplained			(:05) The UnXplained	(:03) The UnXplained			(:04) The UnXplained	(:12:06) The UnXplained			
LIFE	39	108	252	"12 Desperate Hours" (2023)	Samantha Mathis. Premiere.	(:03) "A Rose for Her Grave: The Randy Roth Story" (2023)			(:01) "12 Desperate Hours" (2023)	Samantha Mathis. "Rose for Her Grave"							
LIFEMOV	119	109	253	"Danger in the House" (2022, Suspense)	Rebecca Liddiard.	"Framed by My Sister" (2022)			Scout Taylor-Compton.	(:01) "Danger in the House" (2022)			Rebecca Liddiard.	"Framed by My Sister"			
NBATV	273	156	216	Basketball Stories	NBA GameTime	**** "Raiders of the Lost Ark" (1981)			Harrison Ford, Karen Allen.	*** "Indiana Jones and the Last Crusade" (1989)			Harrison Ford.				
PAR	34	241	241	54th Annual NAACP Image Awards (N)	*** "Zombieland" (2009, Comedy)			Woody Harrelson.	(9:59) ** "Drive Angry 3D" (2011, Action)			Nicolas Cage.	(11:59) * "After Earth"				
SYFY	59	122	244	*** "Despicable Me 2" (2013)	Voices of Steve Carell.	*** "The Wedding Singer" (1998)			Adam Sandler.	* "The Bounty Hunter" (2010)			Jennifer Aniston.				
TBS	33	139	247	The Intern	Burgers	Burgers	Burgers	Burgers	Burgers	*** "The Wedding Singer" (1998)			Adam Sandler.	* "The Bounty Hunter" (2010)			Jennifer Aniston.
TCM	169	132	256	** "Losing Ground" (1982)	Bill Gunn, Seret Scott.	** "The Watermelon Woman" (1996)			Cheryl Dunye.	** "Hunt the Man Down" (1950)			(:45) *** "The Wind and the Lion"				
TLC	45	183	280	Extreme Sisters	Extreme Sisters	Extreme Sisters			Extreme Sisters	Extreme Sisters			Extreme Sisters	Extreme Sisters			
TNT	32	138	245	(5:18) *** "Creed II" (2018, Drama)	Michael B. Jordan.	(:03) *** "Just Mercy" (2019, Drama)			Michael B. Jordan, Jamie Foxx, Brie Larson.	(:03) *** "Amistad" (1997)			Morgan Freeman. Premiere.				
TRAV	49	196	277	Unexplained: C	Unexplained: C	Help! My House Is Haunted			Unexplained: C	Unexplained: C			Unexplained: C	Help! My House Is Haunted			
TRU TV	30	242	246	Imp. Jokers	Imp. Jokers	Inside Jokes	Inside Jokes	Inside Jokes	Inside Jokes	Imp. Jokers	Inside Jokes	Inside Jokes	Inside Jokes	Imp. Jokers	Inside Jokes	Inside Jokes	Inside Jokes
USA	31	105	242	Chicago P.D.	Chicago P.D. "Fagin"	Chicago P.D.	"Army of One"	Chicago P.D.	Chicago P.D.	Chicago P.D. "Reform"	Chicago P.D.	Chicago P.D.	Chrisley	Law & Order: SVU			

tonight's picks



Aaron O'Connell and Alexandra Turshen

6 p.m. on HALL
Movie: Made for Each Other

Searching for perfection can get old real quick. A sculptor (Alexandra Turshen) uses magic to mold her ideal man (Aaron O'Connell) into existence, thinking he'd be exactly what she wanted. But during the process she begins to fall for her real-life friend (Matt Cohen) and embraces the flaws that make love perfectly imperfect in this 2023 romance. Ileana Douglas and Erik Athavale also star.

6 p.m. on LIFE
Movie: 12 Desperate Hours

Val (Samantha Mathis) and her young children are held

hostage by Denny (Harrison Thomas) when he breaks into their house after committing murder earlier in the day. In order to save them and her husband Mark (David Conrad), who is due home at any moment, Val offers to drive Denny wherever he wants and becomes his unwilling accomplice as he continues his rampage. Val tries to befriend Denny to help save the lives of bystanders, herself and even the life of her captor in this 2023 docudrama.

6 p.m. on PAR BET CMTV
MTV MTV2 POP TVLAND
VH1
54th Annual NAACP Image Awards

It's a powerhouse list of nominees at this year's awards, but perhaps none is more interesting than the Entertainer of the Year category, as all nominees are women: Angela Bassett, Mary J. Blige, Viola Davis, Zendaya and Quinta Brunson. The Outstanding Motion Picture category consists of "A Jazzman's Blues," "Black Panther: Wakanda Forever," "Emancipation," "The Woman King," and "Till." "Abbott Elementary" leads nominations in the television and streaming categories.

6 p.m. on TCM
Movie: Losing Ground

Sara (Seret Scott), a popular Black philosophy professor and her insensitive, cheating, flamboyant artist husband, Victor (Bill Gunn), are having a marital crisis. When Victor sells one of his paintings to a museum, the couple celebrates by renting a house outside of the city. The change of scenery is too much for their strained relationship in this 1982 drama, airing as part of the channel's tribute to Black History Month, and also the first feature-length film directed by a Black woman since the 1920s.

6 p.m. on EPIX
Movie: Transformers: Age of Extinction

After the battle between the Autobots and Decepticons leveled Chicago, humanity thinks that all alien robots are a threat. So Harold Attinger (Kelsey Grammer), a CIA agent, establishes a unit designed to hunt them down with the help of another alien robot and industrialist Joshua Joyce (Stanley Tucci). But Cade Yeager (Mark Wahlberg), a farmer and robotics expert, and his family help Prime and the Autobots avoid destruction in this 2014 action film.

6:30 p.m. on KVIA
NBA Basketball

A clash of two of the top teams in the East goes down tonight in the City of Brotherly Love, where Joel Embiid and the Philadelphia 76ers will try to get a modicum of revenge against Jayson Tatum and the Boston Celtics. The Celts certainly showed no love to the Sixers on opening night in Beantown, when Tatum and Jaylen Brown each scored 35 points in leading Boston to a 126-117 victory.

8:03 p.m. on TNT
Movie: Just Mercy

Jamie Foxx received a Screen Actors Guild Award nomination as best supporting actor for his work in this fact-based 2019 legal drama, in which he plays Walter McMillian, a Black prison inmate on Death Row for the 1986 murder of Ronda Morrison, a white woman. McMillian's case catches the attention of idealistic young Harvard law graduate Bryan Stevenson (a top-billed Michael B. Jordan), who has teamed up with a kindred spirit (Brie Larson) to found the Equal Justice Initiative. Rob Morgan, Tim Blake Nelson and Rafe Spall also star.

13TH ANNUAL
LAS CRUCES

ARTS FAIR

MARCH
25TH & 26TH
2023

LAS CRUCES
CONVENTION
CENTER

DAarts.org
575-523-6403
230 S Water St.

DOÑANA
Arts
COUNCIL

SUNDAY DAYTIME

S - Spectrum D - Dish DTV - DirecTV

MOVIES

SPORTS

SPECIALS

FEBRUARY 26, 2023

S	D	DTV	8 AM	8:30	9 AM	9:30	10 AM	10:30	11 AM	11:30	12 PM	12:30	1 PM	1:30	2:30	3 PM	3:30	4 PM	4:30	5 PM	5:30	
PBS-KRWG	2	22	22	Stevens	Aging Backwards 4	Suze Orman's Ultimate Retirement	Eat To Sleep	Collagen Diet With Dr. Josh	Gut Check: Ultimate Health	Demystifying Detox												
CBS-KDBC	3	4	4	News	Face the Nation (N)	Attkisson	College Basketball	Illinois at Ohio State	College Basketball													
ABC-KVIA	7	7	7	News	This Week	Vets-	NBA	NBA Basketball	Phoenix Suns at Milwaukee Bucks.	NBA Basketball: Lakers at Mavericks	Ent. Tonight	News	ABC									
FOX-KFOX	8	14	14	FOX News Sunday	Spotlight	Bucket	Big East	College Basketball	NASCAR RaceDay	NASCAR Cup Series Pala Casino 400. (Live)	FamFeud	FamFeud										
NBC-KTSM	9	9	9	House	State of	Meet the Press (N)	Laughs	Laughs	Outdoors	FIS Freestyle Ski	PGA	PGA Tour Golf The Honda Classic, Final Round. (Live)	Sage Church	News at	NBC							
UNI-KINT	10	-	26	Esta historia	Como dice el dicho	Al punto con Jorge	Aquí y ahora	* "Kangaroo Jack" (2003, Comedia)	República	Rosa de Guadalupe	Rosa de Guadalupe	María	Noticiero									
TEL-KTDO	11	48	48	Fútbol	La Liga	Pro	Pro	Acércate a Rocío	** "The Wild Life" (2016) Ron Allen	** "Kin" (2018) Myles Truitt.	* "Anaconda" (1997) Jennifer Lopez.	Dec.	Noticias									
UMAS-KTFN	13	7593	65	Animal	Animal	Mundo	Rob	Pro	Pro	Pro	Nosotr.	Nosotr.	"Eruption: LA" (2018)	* "CHIPS" (2017) Michael Peña.	"Mechanic: Resurrection"							
CW-KVIA2	14	17	8	Paid Prg.	Destiny	** "Guarding Tess" (1994)																
A&E	43	118	265	Zombie Flip	Zombie Flip	Zombie Flip	WWE Rivals	Biography: WWE Legends "Bret Hart"	Biography: WWE Legends "nWo"	Biography: WWE Legends												
AMC	57	131	254	(7:00) ** "Major League"	*** "Casino" (1995, Crime Drama)	Robert De Niro, Sharon Stone, Joe Pesci.	*** "Moneyball" (2011, Drama)	Brad Pitt, Jonah Hill.	*** "Days of Thunder"													
COMEDY	35	107	249	Parks	Parks	Parks	Parks	Parks/Recreat	Parks	Office	Office	Office	** "The Wedding Ringer" (2015) Kevin Hart.	** "Ride Along 2" (2016) Ice Cube.								
COOK	123	113	232	Best	Best	Bizarre	Bizarre	Delicious	Delicious	Delicious	Delicious	Food	Food	Food	Food	Food	Food	Food	Food	Food	Food	Food
DSC	47	182	278	Homestead Rescue	Homestead Rescue	Naked and Afraid	Naked and Afraid	Naked and Afraid	Naked and Afraid	Naked and Afraid	Naked and Afraid	Naked and Afraid	Naked and Afraid	Naked and Afraid	Naked and Afraid	Naked and Afraid	Naked and Afraid	Naked and Afraid	Naked and Afraid	Naked and Afraid	Naked and Afraid	
E!	37	114	236	"Made of Honor"	"Why Can't My Life Be a Rom-Com?"	** "Made of Honor" (2008)	** "50 First Dates" (2004)	** "Just Go With It" (2011) Adam Sandler.	50 Dates													
ESPN	27	140	206	SportsCenter (N)	College GameDay	Women's College Basketball	Women's College Basketball	XFL Football Teams TBA.	NBA	Basket												
FOOD	40	110	231	Pioneer	Pioneer	Girl-Farm	Girl-Farm	Mary Ma.	Mary Ma.	The Kitchen	Guy's Games	Guy's Games	Guy's Games	Guy's Games	Guy's Games	Guy's Games	Guy's Games	Guy's Games	Guy's Games	Guy's Games	Guy's Games	
FX	29	136	248	Mom	Mom	*** "Iron Man" (2008, Action)	Robert Downey Jr.	** "Iron Man 2" (2010) Robert Downey Jr.	*** "Iron Man 3" (2013) Robert Downey Jr.													
GALA	25	273	404	El Chavo Animado	La escolita VIP (N)	Hospital El Paisa	¡Qué madre tan	La jaula (N)	Cantinflas show	"El extra" (1962) Cantinflas, Alma Delia Fuentes.	Derbez	XH Derbez (N)										
GOLF	24	401	218	LPGA Golf	LPGA Golf	Golf Central	PGA Golf	LPGA Tour Golf	Honda LPGA Thailand, Third Round.	Golf Central (N)	PGA Golf											
HALL	58	185	312	"Right in Front"	"A Summer Romance" (2019, Romance)	"October Kiss" (2015) Ashley Williams.	"The 27-Hour Day" (2021, Romance)	"Love on Harbor Island" (2020)	"Made for Each"													
HGTV	41	112	229	Nate & Jeremiah	Nate & Jeremiah	Nate & Jeremiah	Home Town	Home Town	Home Town	Home Town	Home Town	Home Town	Home Town	Home Town	Home Town	Home Town	Home Town	Home Town	Home Town	Home Town	Home Town	
HISTORY	44	120	269	Modern Marvels	Modern Marvels (N)	Modern Marvels	Modern Marvels	Modern Marvels	Built America	Built America	Built America	Built America	Built America	Built America	Built America	Built America	Built America	Built America	Built America	Built America	Built America	
LIFE	39	108	252	"Spinning Out of Control" (2023)	"Girl Who Escaped"	Escaping Captivity: Kara Robinson Story	"Secret Society of Lies" (2023)	"Secrets in the Marriage" (2023)														
LIFEMOV	119	109	253	"The Walls Are Watching" (2022)	"Secrets in the Basement" (2020)	"Is There a Killer on My Street?" (2018)	"Killer Dream Home" (2020) Eve Mauro	"If Walls Could Talk" (2022, Suspense)														
NBATV	273	156	216	Game	Game	Game of the Day	NBA TV Marquee Matchup	NBA G League Basketball	Basketball Stories	NBA GameTime												
PAR	34	241	241	Bar Rescue	Bar Rescue	Bar Rescue	Bar Rescue	Bar Rescue	Bar Rescue	Bar Rescue	Bar Rescue	Bar Rescue	Bar Rescue	Bar Rescue	Bar Rescue	Bar Rescue	Bar Rescue	Bar Rescue	Bar Rescue	Bar Rescue	Bar Rescue	
SYFY	59	122	244	Charmed	Charmed	Charmed	*** "Despicable Me" (2010)	*** "Despicable Me 2" (2013)	*** "Drive Angry 3D" (2011, Action)	"Zombieland"												
TBS	33	139	247	Friends	Friends	Friends	Friends	Friends	Friends	** "Mr. & Mrs. Smith" (2005, Action) Brad Pitt.	** "Ocean's 8" (2018, Comedy)	Sandra Bullock.	Big Bang	Big Bang								
TCM	169	132	256	** "Hunt the Man Down"	*** "Sylvia Scarlett"	(:15) *** "Mr. Skeffington" (1944, Drama)	Bette Davis.	*** "Brigadoon" (1954) Gene Kelly.	*** "Light in the Piazza" (1962)													
TLC	45	183	280	Best Friends	Best Friends	1000-Lb. Sisters	1000-Lb. Sisters	1000-Lb. Sisters	1000-Lb. Sisters	1000-Lb. Sisters	90 Day: Other	90 Day: Other	90 Day: Other	90 Day: Other	90 Day: Other	90 Day: Other	90 Day: Other	90 Day: Other	90 Day: Other	90 Day: Other		
TNT	32	138	245	NCIS: New Orleans	NCIS: New Orleans	NCIS: New Orleans	(:05) *** "Twister" (1996) Bill Paxton	*** "Ready Player One" (2018) Tye Sheridan.														
TRAV	49	196	277	Bey.- Unknown	Bey.- Unknown	Michigan Hell House	A Haunting	A Haunting	A Haunting	A Haunting	A Haunting	A Haunting	A Haunting	A Haunting	A Haunting	A Haunting	A Haunting	A Haunting	A Haunting	A Haunting		
TRU TV	30	242	246	Jokers	Jokers	Jokers	Jokers	Jokers	Jokers	Jokers	Jokers	Jokers	Jokers	Jokers	Jokers	Jokers	Jokers	Jokers	Jokers	Jokers	Jokers	
USA	31	105	242	Soccer	Goal	Law & Order: SVU	College Basketball	College Basketball	Law & Order: SVU	Law & Order: SVU	Law & Order: SVU	Law & Order: SVU	Law & Order: SVU	Law & Order: SVU	Law & Order: SVU	Law & Order: SVU	Law & Order: SVU	Law & Order: SVU	Law & Order: SVU	Law & Order: SVU		

tonight's picks



James Spader

6 p.m. on LIFE

Movie: The Paramedic Who Stalked Me

After a near-fatal accident, Chloe (Lexi Minnetree) finds herself the target of Matt (Andrew Spach), the EMT who saved her life. But she reminds him of his high school love who died tragically years ago — and he will do anything to have her back in his life. But his obsession has Chloe fearing for her life once again in this 2023 thriller. Maeve Quinlan and Ashton Leigh also star.

8 p.m. on TNT
Movie: Mortal Kombat

Based on the video game franchise of the same title, this visually dazzling and action-packed 2021 martial arts fantasy film from first-time feature director Simon McQuoid earned critical kudos for its action sequences and visual effects, while also setting viewership records on the streaming platform where it premiered. Lewis Tan stars as Cole Young, a washed-up mixed martial arts fighter who is ignorant of his family lineage and can't understand why an assassin called Sub-Zero is stalking him. Jessica McNamee, Josh Lawson and Mehcad Brooks also star.

8 p.m. on HMM
Movie: A Nashville Legacy

Naima (Andrea Lewis) just moved to Nashville, where she is interning as a curator at a well-known museum — and there she meets Damian (Pooch Hall), a volunteer. But Damian is actually the heir to the Berryhall Records empire, run by his father Franklin Berryhall (Stan Shaw). The two begin to get close, bonding over their love for music and their desire to leave their respective marks on the world

in this 2023 romantic musical comedy.

8:01 p.m. on A&E
WWE Rivals

The Undertaker dominated most of the WWE roster in the mid 1990's, but needed an opponent who could push him both physically and mentally. Enter Mankind (aka Mick Foley). He became that perfect foil for "The Deadman." Together, these larger-than-life characters crafted unforgettable moments every time the bell rang, culminating in their 1998 Hell in a Cell match. A roundtable including Freddie Prinze Jr., Booker T, Natalya, D-Von Dudley and John Bradshaw Layfield discuss this quintessential rivalry in the new episode "Undertaker vs. Mankind."

9 p.m. on KTSM
The Blacklist

After eliminating Liz Keen's murderer, Red (James Spader) has finally satiated his need for revenge. Unfortunately for Red, No. 84 on the blacklist escapes from prison and informs many of the other blacklist criminals that Red is an FBI informant in the Season 10 premiere. Revenge may have been accomplished by Red, but the same can't be said for the individuals he has

put behind bars, and his safety is now compromised. Anya Banerjee joins the cast as Siya Malik.

10 p.m. on E!

Movie: Royal Rendezvous

Cat (Isabella Gomez), a chef from East Los Angeles, is invited to a palatial manor in Ireland to cook for a royal banquet in an effort by James (Ruairi O'Connor), a Lord, to convince his grandmother not to sell their amazing home. But a budding romance between Cat and James threatens to derail the entire plan in this 2023 romance.

10 p.m. on NGC
Wicked Tuna

It's the beginning of bluefin season and Gloucester's toughest competitors kick off the battle for the first fish of the season and for the title of G.O.A.T. (greatest of all time). But a new contender arrives to disrupt the ranks of Gloucester's seafarers, as Captain Michelle Banciewicz and first mate Lea Pinaud of F/V No Limits enters the competition looking to impress with their catch in the Season 12 premiere episode "Who's the G.O.A.T. Boat?" Another new episode immediately follows.

**DO YOU NEED AN EXPERIENCED PLUMBER?
CALL US FIRST!**

MCC
Metal Craft Co.
PLUMBING DIVISION
575-524-8653

FAMILY OWNED & OPERATED
More than 60 years of combined plumbing experience

924 W. Picacho Ave.
www.metalcraftco.com

Commercial & Residential
• New Construction • Remodels
• Service & Repairs • Tankless Water Heaters
• Water Treatment Systems
• Underground Leaks • Circulating Pumps
• Natural Gas • And More

MM License # 018830
Tx Lic. #TACLA021079C

LENNIX ACROBARK THE PLUMBING PEOPLE
DELTA NAVIEN

SUNDAY EVENING

S - Spectrum D - Dish DTV - DirecTV

MOVIES

SPORTS

SPECIALS

FEBRUARY 26, 2023

	S	D	DTV	6 PM	6:30	7 PM	7:30	8 PM	8:30	9 PM	9:30	10 PM	10:30	11 PM	11:30	12 AM	12:30		
PBS-KRWG	2	22	22	Your Legisla	Weekend	Elvis Presley: '68 Comeback Special	Endeavour: A Countdown to the Final					Billy Joel: Live at Yankee Stadium					Your Legisla	Weekend	
CBS-KDBC	3	4	4	60 Minutes (N)		The Equalizer (N)	East New York (N)			NCIS: Los Angeles (N)			To Be Announced			Magnum P.I.	SEAL Team		
ABC-KVIA	7	7	7	Funniest Home Videos		American Idol New Orleans, Las Vegas and Nashville. (N)	The Company You Keep (N)					ABC 7 at 10	ABC 7 Xtra	(:05) S.W.A.T. "Donor"	(12:05) The Good Doctor				
FOX-KFOX	8	14	14	Next Level Chef		Simpsons	Great North	Burgers	Family Guy	KFOX14 News at Nine			Full Measure	Big Bang	Big Bang	Mod Fam	Mod Fam	Mod Fam	
NBC-KTSM	9	9	9	Dateline NBC		Magnum P.I. (N)			The Blacklist			KTSM News	Joel Osteen	In Touch	Outdoorsman	Weather Gone Viral			
UNI-KINT	10	-	26	Aquí y ahora (N)		¿Quién es la máscara? Los cinco que conservan sus máscaras. (N)					Tal para cual			Noticiero Uni	Noticiero Uni	La jugada (N) (Live)		Vecinos	Renta
TEL-KTDO	11	48	48	La casa de los famosos (N)		** "Skyscraper" (2018, Acción) Dwayne Johnson.					Noticias T	Zona mixta	Decisiones	Decisiones extremas			Programa		
UMAS-KTFN	13	7593	65	Mechanic	** "Born to Raise Hell" (2010, Suspense) Steven Seagal.	"Enemies Closer" (2013, Acción) (N)			** "Mechanic: Resurrection" (2016) Jason Statham.			Familia Diez			Familia Diez				
CW-KVIA2	14	17	8	Sheldon	Sheldon	Animals	Animals	Whose Line	Whose Line	Seinfeld	Seinfeld	Kickin' It: With Byron Allen			SOS: How to Survive		Top 10		
A&E	43	118	265	Biography: WWE Legends "Jake The Snake Roberts" (N)					(:01) WWE Rivals (N)			(:04) WWE Rivals			(:03) Biography: WWE Legends "Jake The Snake Roberts"			(12:04) WWE Rivals	
AMC	57	131	254	(4:30) "Days of Thunder"		Mayfair Witches (N)			(:02) Mayfair Witches			(1990, Action) Tom Cruise, Robert Duvall.			(:34) Mayfair Witches			Moneyball	
COMEDY	35	107	249	** "Get Hard" (2015, Comedy) Will Ferrell, Kevin Hart.					** "Central Intelligence" (2016) Dwayne Johnson.					** "Central Intelligence" (2016) Dwayne Johnson.			South Park	South Park	
COOK	123	113	232	Carnival Eats	Carnival Eats	Carnival Eats	Carnival Eats	Man v. Food	Man v. Food	Man v. Food	Man v. Food	Carnival Eats	Carnival Eats	Carnival Eats	Carnival Eats	Man v. Food	Man v. Food		
DSC	47	182	278	Naked and Afraid An MMA fighter and a paramedic. (N)					(:03) Naked and Afraid			(:03) Naked and Afraid			Naked and Afraid An MMA fighter and a paramedic.			(12:03) Naked and Afraid	
E!	37	114	236	(5:30) ** "50 First Dates" (2004)					** "Just Go With It" (2011) Adam Sandler, Jennifer Aniston.			"Royal Rendezvous" (2023) Isabella Gomez. Premiere.					"Royal Rendezvous" (2023)		
ESPN	27	140	206	NBA Basketball: Timberwolves at Warriors					NBA Basketball Los Angeles Clippers at Denver Nuggets. (Live)					(:35) SportsCenter With Scott Van Pelt (N)			SportsCenter W/Van Pelt		
FOOD	40	110	231	Tournament of Champions "Randomizer Gone Wild" (N)					Alex vs America (N)			Alex vs America			Tournament of Champions "Randomizer Gone Wild"			Alex vs America	
FX	29	136	248	Iron Man 3	*** "Ant-Man and The Wasp" (2018) Paul Rudd, Evangeline Lilly.					*** "Avengers: Infinity War" (2018, Action) Robert Downey Jr., Chris Hemsworth, Josh Brolin.			Avengers						
GALA	25	273	404	¿Cuál es el bueno? Danielle Dithurbide y Paul Stanley.					Faisy Nights (N)			& noche			Programa	Programa	Programa	Programa	
GOLF	24	401	218	(5:00) PGA Tour Golf The Honda Classic, Final Round.					LPGA Tour Golf Honda LPGA Thailand, Third Round.					PGA Golf					
HALL	58	185	312	"Made for Each Other"					The Way Home (N)			Golden Girls	Golden Girls	Golden Girls	Golden Girls	Frasier	Frasier	Frasier	Frasier
HGTV	41	112	229	Home Town "Blue Heaven"					(:01) Home Town (N)			Hunters	Hunters Int'l	Hunters	Hunters Int'l	Home Town "Blue Heaven"	(:01) Home Town	Hunters	Hunters Int'l
HISTORY	44	120	269	The Food That Built America					The Food That Built America			The Food That Built America			The Food That Built America			The Food That Built America	
LIFE	39	108	252	"The Paramedic Who Stalked Me" (2023) Lexi Minetree.					(:03) "Abducted: The Mary Stauffer Story" (2019, Drama)			(:01) "The Paramedic Who Stalked Me" (2023, Suspense)			"Abducted: The"				
LIFEMOV	119	109	253	"Secrets in the Building" (2023) Shemeka Wright.					"Killer Contractor" (2019) Alyshia Ochse, Zac Titus.			(:01) "Secrets in the Building" (2023) Shemeka Wright.			(12:01) "Killer Contractor"				
NBATV	273	156	216	(4:00) NBA GameTime					NBA GameTime					NBA Game			NBA Game	NBA Game	NBA Game
PAR	34	241	241	Bar Rescue					Bar Rescue "Game Over"			Bar Rescue (N)			Bar Rescue			Bar Rescue	
SYFY	59	122	244	(5:00) *** "Zombieland"					** "The Purge" (2013) Ethan Hawke, Lena Headey.			(8:59) ** "The Purge: Election Year" (2016, Action) Frank Grillo.			(:29) ** "Gamer" (2009) Gerard Butler.				
TBS	33	139	247	Big Bang		Big Bang		Big Bang		Big Bang		Silicon Valley (:38) *** "Star Wars: The Force Awakens" (2015) Harrison Ford, Mark Hamill.			(:39) ** "Ocean's 8" (2018, Comedy)				
TCM	169	132	256	**** "All the President's Men" (1976, Docudrama) Robert Redford.					** "In My Country" (2004) Samuel L. Jackson. Premiere.			*** "Within Our Gates" (1920, Drama)			** "Fallen Angels" (1995)				
TLC	45	183	280	90 Day Fiancé: The Other Way (N)					MILF Manor (N)			90 Day: Other			90 Day Fiancé: The Other Way			MILF Manor	
TNT	32	138	245	(4:05) *** "Avengers: Endgame" (2019) Chris Evans					** "Mortal Kombat" (2021, Action) Lewis Tan. Premiere.			(:15) *** "X-Men: Days of Future Past" (2014, Action) Hugh Jackman, James McAvoy.							
TRAV	49	196	277	A Haunting					The Devil's Academy All hell breaks loose at a school. (N)					A Haunting			The Devil's Academy All hell breaks loose at a school.		
TRU TV	30	242	246	Imp. Jokers	Imp. Jokers	Imp. Jokers	Imp. Jokers	Imp. Jokers	Imp. Jokers	Imp. Jokers	Imp. Jokers	Imp. Jokers	Imp. Jokers	Imp. Jokers	Imp. Jokers	Imp. Jokers	Imp. Jokers	World's Dumbest ...	
USA	31	105	242	Law & Order: SVU					Law & Order: SVU					Law & Order: SVU			Law & Order: SVU		

WEEKDAY DAYTIME

S - Spectrum D - Dish DTV - DirecTV

	S	D	DTV	8 AM	8:30	9 AM	9:30	10 AM	10:30	11 AM	11:30	12 PM	12:30	1 PM	1:30	2 PM	2:30	3 PM	3:30	4 PM	4:30	5 PM	5:30						
PBS-KRWG	2	22	22	Wild	Curious	Tiger	Rosie	Sesame	Work It	Donkey	Pink	Elinor	Nature	Democracy Now!	Varied Programs			Almas	Xavier	Odd	Arthur	News	News						
CBS-KDBC	3	4	4	CBS Mornings	Let's Make a Deal	The Price Is Right			Young & Restless			CBS4No	Bold	The Talk			Judge Jerry	The People's Court			Jdg Judy	Jdg Judy	CBS	News					
ABC-KVIA	7	7	7	Good Morning	Kelly and Ryan	The View			GMA3: What			News at Noon			General Hospital			Tamron Hall	Kelly Clarkson			ABC 7 News at 4			News	ABC			
FOX-KFOX	8	14	14	KFOX14 News	Kimberly and Sherri	The People's Court			Divorce			Divorce	Hot	Hot	Judge Mathis			You Bet	You Bet	FamFeud			FamFeud	KFOX14 News					
NBC-KTSM	9	9	9	(7:00) Today	Today 3rd Hour			Today-Hoda			Rachael Ray			News at Noon			NBC News Daily			Karamo	Dr. Phil			TMZ	News	News at	NBC		
UNI-KINT	10	-	26	(6:00) ¡Despierta América!					Ringo	Noticiero			Nosotr.	Hoy	Corazón guerrero			Como dice el dicho			El gordo y la flaca			Primer impacto	Noticiero	Noticiero			
TEL-KTDO	11	48	48	(6:00) Hoy día					Caso cerrado	Caso	Acceso	Corazón			Noticias	Acércate a Rocío			En casa con			La mesa caliente			(2:58) Al rojo vivo	Noticiero	Noticiero	Noticiero	Noticias
UMAS-KTFN	13	7593	65	(7:05) Rebelde					(:05) Maria Mercedes	Mañana-Siempre			Soy tu dueña			Como dice el dicho			Enamorandome de Ramón			La fea más bella			Tres veces Ana				
CW-KVIA2	14	17	8	Hatchett	Hatchett	Dateline			Dateline			Barry	Barry	Jerry Springer			Steve Wilkos Show			Maury	Piction			Piction	black-ish	Neighbor	House	Last Man	
A&E	43	118	265	Varied Programs																First 48	Varied	First 48	Varied	First 48	Varied				
AMC	57	131	254	Movie	Varied Programs																								
COMEDY	35	107	249	Brooklyn	Brooklyn	Brooklyn	Brooklyn	Brooklyn	South Pk	South Pk	South Pk	South Pk	South Pk	South Pk	South Pk	South Pk	South Pk	South Pk	South Pk	South Pk	South Pk	South Pk	South Pk	South Pk					
COOK	123	113	232	Varied Programs																									
DSC	47	182	278	Homestead Rescue	Homestead Rescue	Homestead Rescue			Varied Programs																				
E!	37	114	236	Varied Programs																									
ESPN	27	140	206	First Take					SportsCenter			Baseball			Varied Programs			NFL Live			Around	Pardon	SportsCenter			Basket	Varied		
FOOD	40	110	231	Varied Programs																									
FX	29	136	248	Mom	Mom	Varied Programs																							
GALA	25	273	404	María	María	La familia P. Luche			Una familia de diez			Nosotros los.			Vecinos			Güereja			Güereja	Mi quer	Mi quer	Se ren	Se ren	María	María	La familia P. Luche	
GOLF	24	401	218	PGA Golf	Varied Programs			Golf Today			Varied Programs			College	Women's College Golf			Central			Varied Programs								
HALL	58	185	312	Golden	Golden	Golden	Golden	Movie																					
HGTV	41	112	229	Varied Programs																									
HISTORY	44	120	269	Varied Programs																									
LIFE	39	108	252	The Closer			Major Crimes			Major Crimes			Major Crimes			Rizzoli & Isles			Rizzoli & Isles			Rizzoli & Isles			Castle			Castle	Castle
LIFEMOV	119	109	253	Movie																									
NBATV	273	156	216	Varied Programs					Game of the Day			Varied Programs														Game	Varied		
PAR	34	241	241	Bar Rescue			Bar Rescue			Law & Order			Law & Order			(:01) Law & Order	(:02) Law & Order	Two Men	Two Men	Two Men	Two Men	Two Men	Two Men	Two Men	Two Men	Two Men	Two Men	Two Men	
SYFY	59	122	244	Movie	(:31) Movie	Varied Programs																							
TBS	33	139	247	Broke	Broke	Friends	Friends	Friends	Friends	Friends	Friends	Friends	Friends	Friends	Friends	Friends	Friends	Friends	Sheldon	Sheldon	Sheldon	Sheldon	Sheldon	Big Bang	Big Bang				
TCM	169	132	256	(7:15) Movie					Varied Programs																				
TLC	45	183	280	Varied Programs																									
TNT	32	138	245	Supernatural					Varied Programs																				
TRAV	49	196	277	Varied Programs																									
TRU TV	30	242	246	truTV Top Funniest	MythBusters			MythBusters			MythBusters			Jokes	Jokes	Jokes	Jokes	Jokes	Jokes	Jokes	Jokes	Jokes	Jokes	Jokes	Jokes	Jokes			
USA	31	105	242	Law & Order: SVU					Law & Order: SVU					Law & Order: SVU					Law & Order: SVU					Varied Programs					

MONDAY EVENING

S - Spectrum D - Dish DTV - DirecTV

MOVIES

SPORTS

SPECIALS

FEBRUARY 27, 2023

	S	D	DTV	6 PM	6:30	7 PM	7:30	8 PM	8:30	9 PM	9:30	10 PM	10:30	11 PM	11:30	12 AM	12:30	
PBS-KRWG	2	22	22	NewsHour	BBC News	John Denver's Rocky Mountain High		Elvis Costello/Burt Bacharach Sessions		Rick Steves	Nitty Gritty Dirt Band the Hits, History						PBS NewsHour	
CBS-KDBC	3	4	4	Jeopardy! (N)	Wheel	Neighbor	Bob-Abishola	NCIS "Unusual Suspects"		NCIS: Hawai'i (N)		CBS4 News	Late Show-Colbert	James Corden			Paid Program	
ABC-KVIA	7	7	7	News	Ent. Tonight	The Bachelor (N)				(:01) The Good Doctor (N)	News	(:35) Jimmy Kimmel Live!	(:37) Nightline	Ent. Tonight		Hollywood		
FOX-KFOX	8	14	14	Big Bang	Big Bang	Alert: Missing Persons Unit (Season Finale) (N)				KFOX News at Nine (N)	Mod Fam	Mod Fam	iCRIME	Simpsons	Two Men	Two Men		
NBC-KTSM	9	9	9	KTSM 9 News at 6 (N)	America's Got Talent: All-Stars	The winner is revealed. (N)				Quantum Leap (N)	KTSM News	Tonight Show-J. Fallon	Late Night With Seth Meyers	(:37) TMZ (N)				
UNI-KINT	10	-	26	La rosa de Guadalupe (N)	Perdona nuestros pecados	Mi camino es amarte (N)				Cabo (N)	Noticiero Uni.	Noticiero	Contacto deportivo (N) (Live)	Mi camino es amarte				
TEL-KTDO	11	48	48	La casa de los famosos (N)		El señor de los cielos (N)				Amor y traición (N)	Noticiero	Noticias	Caso cerrado	Enemigo íntimo				
UMAS-KTFN	13	7593	65	¡Siéntese quien pueda! (N)	(6:58) Enamorándonos (N) (Live)					Resistiré (N)	Como dice el dicho (N)	¡Siéntese quien pueda!	Resistiré					
CW-KVIA2	14	17	8	Sheldon	Sheldon	All American		All American: Homecoming		Seinfeld	Seinfeld	Sheldon	Neighbor	Last-Standing	25 Words	Pawn Stars	Storage Wars	
A&E	43	118	265	The First 48 "Devil's Trail"	The First 48	(:01) The First 48		(:04) The First 48		(:03) The First 48	(:03) The First 48	(:03) The First 48	(:03) The First 48	(12:04) The First 48				
AMC	57	131	254	* "Vegas Vacation" (1997, Comedy) Chevy Chase.		*** "National Lampoon's Christmas Vacation" (1989)		(:15) ** "National Lampoon's European Vacation"						"National Lamp."				
COMEDY	35	107	249	The Office	The Office	The Office	The Office	The Office	The Office	The Office	The Office	The Office	The Office	The Office	The Office	The Office	Daily Show	(:35) Seinfeld
COOK	123	113	232	Delicious	Delicious	The Zimmern	The Zimmern	Delicious	Delicious	Delicious	Delicious	Delicious	Delicious	The Zimmern	The Zimmern	Delicious	Delicious	
DSC	47	182	278	Street Outlaws "Street Wars" Nova launches the first Street Wars. (N)		(:02) Street Outlaws		Street Outlaws "Street Wars" Nova launches the first Street Wars.										
E!	37	114	236	Mod Fam	Mod Fam	Mod Fam	Mod Fam	Mod Fam	Mod Fam	Mod Fam	Mod Fam	Mod Fam	Mod Fam	Mod Fam	Mod Fam	Mod Fam	E! News (N)	Sex-City
ESPN	27	140	206	College Basketball	College Basketball (Live)			SportsCenter W/Van Pelt		SportsCenter (N) (Live)	SportsCenter (N) (Live)	SportsCenter (N) (Live)	SportsCenter (N) (Live)	SportsCenter (N) (Live)	SportsCenter (N) (Live)	SportsCenter (N) (Live)		
FOOD	40	110	231	Kids Baking Championship	Chopped	Chopped		Chopped		Kids Baking Championship	Chopped	Chopped	Chopped	Chopped	Chopped	Chopped		
FX	29	136	248	(5:30) ** "Con Air" (1997) Nicolas Cage, John Cusack.		*** "The Rock" (1996, Action) Sean Connery, Nicolas Cage, Ed Harris.		*** "The Rock" (1996, Action) Sean Connery, Nicolas Cage, Ed Harris.							*** "The Rock" (1996) Sean Connery, Nicolas Cage.			
GALA	25	273	404	Una familia de diez (N)	Nosotros los guapos (N)	Vecinos		40 y 20	40 y 20	Renta	Renta	Alma de	Alma de	Simón dice	Simón dice			
GOLF	24	401	218	PGA Tour Golf The Honda Classic, Final Round.								Women's College Golf 2023 Darius Rucker Intercollegiate, First Round.						
HALL	58	185	312	"Love at First Glance" (2017) Amy Smart, Adrian Grenier.		Golden Girls	Golden Girls	Golden Girls	Golden Girls	Golden Girls	Golden Girls	Golden Girls	Golden Girls	Frasier	Frasier	Frasier	Frasier	
HGTV	41	112	229	Down Home Fab	Down Home Fab	House Hunters (N)		Hunters	Hunters Int'l	Down Home Fab	House Hunters	House Hunters	House Hunters	Hunters	Hunters	Hunters Int'l		
HISTORY	44	120	269	History's Greatest Mysteries	History's Greatest Mysteries	History's Greatest of All		History's Greatest Mysteries		History's Greatest of All	History's Greatest Mysteries	History's Greatest of All	History's Greatest of All	History's Greatest of All	History's Greatest of All	History's Greatest Mysteries		
LIFE	39	108	252	Castle "Castle, P.I."	Castle	(:03) Castle "I, Witness"		(:03) Castle "Resurrection"		(:01) Castle "Castle, P.I."	(:01) Castle "Castle, P.I."	(:01) Castle	(:01) Castle	(12:04) Castle "I, Witness"				
LIFEMOV	119	109	253	"Labor, Lies and Murder" (2022, Suspense) Brooke Burfitt.		"Sinister Switch" (2021) Emily Alatalo, Steve Belford.		(:01) "Labor, Lies and Murder" (2022) Brooke Burfitt.		(:01) "Sinister Switch"	(:01) "Sinister Switch"	(:01) "Sinister Switch"	(:01) "Sinister Switch"	(12:01) "Sinister Switch"				
NBATV	273	156	216	NBA Basketball: Heat at 76ers	NBA TV Postgame Show	NBA Game	NBA Game	NBA Game	NBA Game	NBA Game	NBA Game	NBA Game	NBA Game	NBA Game	NBA Game	NBA Game	NBA Game	
PAR	34	241	241	*** "Dirty Dancing" (1987, Romance) Jennifer Grey, Patrick Swayze.		*** "Dirty Dancing" (1987, Romance) Jennifer Grey, Patrick Swayze.		*** "Fifty Shades of Grey" (2015) Dakota Johnson.										
SYFY	59	122	244	"Kingsman: Serv"	*** "Independence Day" (1996, Science Fiction) Will Smith, Bill Pullman.			(:03) *** "Kingsman: The Secret Service" (2014, Action) Colin Firth, Michael Caine.										
TBS	33	139	247	Big Bang	Big Bang	Big Bang	Big Bang	American	American	American	American	ELEAGUE Presents (N) (Live)	American	American	American	American		
TCM	169	132	256	**** "The Man Who Shot Liberty Valance" (1962)		(:15) *** "A Walk in the Sun" (1945) Dana Andrews, Richard Conte.		*** "Day for Night" (1973) Jacqueline Bisset.									French	
TLC	45	183	280	Darcey & Stacey	Darcey & Stacey (N)	Extreme Sisters (N)		1000-Lb. Sisters		Darcey & Stacey	Darcey & Stacey	Darcey & Stacey	Darcey & Stacey	Extreme Sisters				
TNT	32	138	245	(5:15) *** "Thor: Ragnarok" (2017) Chris Hemsworth.		(:15) True Blood "Sparks Fly Out"		*** "Thor: Ragnarok" (2017) Chris Hemsworth, Tom Hiddleston.										
TRAV	49	196	277	Mysteries of the Unknown (N)		Mysteries of the Unknown		Mysteries of the Unknown		Mysteries of the Unknown	Mysteries of the Unknown	Mysteries of the Unknown	Mysteries of the Unknown	Mysteries of the Unknown				
TRU TV	30	242	246	Imp. Jokers	Imp. Jokers	Imp. Jokers	Imp. Jokers	** "Jurassic World" (2015) Chris Pratt, Bryce Dallas Howard.		** "Jurassic World" (2015) Chris Pratt, Bryce Dallas Howard.								
USA	31	105	242	WWE Monday Night RAW (N) (Live)		Chrisley	Chrisley	Chrisley	Chrisley	Chrisley	Chrisley	Chrisley	Chrisley	Chrisley	Chrisley	Chrisley	Chrisley	



CROSS CITY BLUES

WITH **MARTY RACINE**

SATURDAYS 9 PM - MIDNIGHT

NM STATE PUBLIC MEDIA

PBS npr

50 Years of Service

90.7 FM AND KRWG.ORG

KRWG PUBLIC MEDIA

tonight's picks



Rachel Hargrove

6 p.m. on DSC Street Outlaws

The fastest drivers look to cash in as Nova launches the first-ever "Street Wars," also the title of this new episode, where winners from each race this season come back for a winner-takes-all, big-money challenge. Things kick off with 405 vs. everyone else, but after Round 1, it's every racer for themselves. Buckle up for all the action!

6 p.m. on BRAVO Below Deck

Chef Rachel wows the guests and delivers a dinner to remember, while the crew throws the pageant queen guests a 1980s party that is totally tubular. Meanwhile,

guest LaQuish continues to be a pain and annoy the interior team. And Ross is forced to reprimand his boat crush in the new episode "Big Deck Energy."

11 p.m. on FREEFRM The Watchful Eye

The masks are about to come off as Elena (Mariel Molino) sneaks into a masquerade ball hosted by residents of the Greybourne. And while everyone is otherwise occupied, Roman (Andres Velez) searches Mrs. Ivey's (Kelly Bishop) apartment for answers. Making matters worse, things get uncomfortable when Ginny (Aliyah Royale) confronts Elena about her identity in the new episode "Save New York."

We Have Your Windows Covered!



Spring CREST CUSTOM DRAPERIES

Call us to set up an appt to visit our showroom and view the wide selection of window coverings, draperies, bedding and custom furniture selections to choose from.

2310 N. Temple • (575) 526-2880 • springcrestnm.com

TUESDAY EVENING

S - Spectrum D - Dish DTV - DirecTV

MOVIES

SPORTS

SPECIALS

FEBRUARY 28, 2023

	S	D	DTV	6 PM	6:30	7 PM	7:30	8 PM	8:30	9 PM	9:30	10 PM	10:30	11 PM	11:30	12 AM	12:30
PBS-KRWG	2	22	22	NewsHour	News 22 (N)	Black Broadway: A Proud History, A Limitless Future		Tommy Emmanuel, CGP: Accomplish Live!		Jimi Hendrix: Electric Church							PBS NewsHour
CBS-KDBC	3	4	4	Jeopardy! (N)	Wheel	FBI (N)		FBI: International (N)		FBI: Most Wanted (N)		CBS4 News		Late Show-Colbert	James Corden		Paid Program
ABC-KVIA	7	7	7	News	Ent. Tonight	The Rookie (N)		The Rookie: Feds "Payback"		Will Trent (N)		News		(:35) Jimmy Kimmel Live!	(:37) Nightline	Ent. Tonight	Hollywood
FOX-KFOX	8	14	14	Big Bang	Big Bang	9-1-1: Lone Star (N)		(:01) Accused (N)		KFOX News at Nine (N)		Mod Fam		Mod Fam	iCRIME	Simpsons	Two Men
NBC-KTSM	9	9	9	KTSM 9 News at 6 (N)		Night Court	American	La Brea (N)		La Brea (N)		KTSM News		Tonight Show-J. Fallon		Late Night With Seth Meyers	(:37) TMZ (N)
UNI-KINT	10	-	26	La rosa de Guadalupe (N)		Perdona nuestros pecados		Mi camino es amarte (N)		Cabo Lucía amenaza a Sofía.		Noticiero Uni.		Noticiero	Contacto deportivo (N) (Live)	Mi camino es amarte	
TEL-KTDO	11	48	48	La casa de los famosos (N)				El señor de los cielos (N)		Amor y traición (N)		Noticiero		Noticias	Caso cerrado "G2 en Miami"	Enemigo íntimo	
UMAS-KTFN	13	7593	65	¡Siéntese quien pueda! (N)		(6:58) Enamorándonos (N) (Live)				Resistiré (N)		Como dice el dicho (N)		¡Siéntese quien pueda!		Resistiré	
CW-KVIA2	14	17	8	Sheldon	Sheldon	The Winchesters (N)		The Flash "Hear No Evil"		Seinfeld	Seinfeld	Sheldon	Neighbor	Last-Standing	25 Words	Pawn Stars	Storage Wars
A&E	43	118	265	Neighbor.	Neighbor.	Neighbor.	Neighbor.	Neighbor.	Neighbor.	Neighbor.	Neighbor.	Neighbor.	Neighbor.	Neighbor.	Neighbor.	Neighbor.	Neighbor.
AMC	57	131	254	(4:30) *** "Rocky III"		** "Rocky IV" (1985) Sylvester Stallone, Talia Shire.				That Dirty Black Bag (N)		(:05) *** "The Perfect Storm" (2000, Suspense) George Clooney, Mark Wahlberg.					
COMEDY	35	107	249	The Office	The Office	The Office	The Office	The Office	The Office	The Office	The Office	The Office	The Office	The Office	The Office	The Office	Daily Show
COOK	123	113	232	Man v. Food	Man v. Food	Man v. Food	Man v. Food	Bourdain: No Reservations		Bourdain: No Reservations		Man v. Food	Man v. Food	Man v. Food	Man v. Food	Man v. Food	Bourdain: No Reservations
DSC	47	182	278	Homestead Rescue	Marty brings water to the property.			(:01) Homestead Rescue		(:01) Homestead Rescue		Homestead Rescue	Marty brings water to the property.				(12:01) Homestead Rescue
E!	37	114	236	Mod Fam	Mod Fam	Mod Fam	Mod Fam	Mod Fam	Mod Fam	Mod Fam	Mod Fam	Mod Fam	Mod Fam	Mod Fam	Mod Fam	Mod Fam	Everything I Know
ESPN	27	140	206	College Basketball		College Basketball Teams TBA. (Live)				SportsCenter W/Van Pelt		SportsCenter (N) (Live)		SportsCenter (N) (Live)		SportsCenter (N) (Live)	SportsCenter (N) (Live)
FOOD	40	110	231	Chopped (N)		Superchef Grudge Match (N)		Chopped		Chopped "Epic Burgers!"		Superchef Grudge Match		Chopped		Chopped	Chopped "Epic Burgers!"
FX	29	136	248	*** "Mission: Impossible -- Fallout" (2018, Action) Tom Cruise, Henry Cavill.						** "I, Robot" (2004, Science Fiction) Will Smith, Bridget Moynahan.						** "I, Robot" (2004) Will Smith.	
GALA	25	273	404	Una familia de diez (N)		Nosotros los guapos (N)		Vecinos (N)		40 y 20	40 y 20	Renta	Renta	Alma de	Alma de	Alma de	Simón dice
GOLF	24	401	218	Golf's Greatest Rounds		Women's College Golf 2023 Darius Rucker Intercollegiate, Second Round.						Golf Central		Golf		Alfa de	PGA TOUR
HALL	58	185	312	"Roadhouse Romance" (2021) Lauren Alaina, Tyler Hynes.		Golden Girls	Golden Girls	Golden Girls	Golden Girls	Golden Girls	Golden Girls	Golden Girls	Golden Girls	Frasier	Frasier	Frasier	Frasier
HGTV	41	112	229	Fixer to Fabulous	Fixer to Fabulous (N)	Hunters	Hunters Int'l	Hunters	Hunters Int'l	Hunters	Hunters Int'l	Fixer to Fabulous		Hunters	Hunters Int'l	Hunters	Hunters Int'l
HISTORY	44	120	269	Oak Island: Digging Deeper		The Curse of Oak Island (N)		History's Greatest Heists		The Curse of Oak Island		Oak Island: Digging Deeper		The Curse of Oak Island		History's Greatest Heists	
LIFE	39	108	252	Rizzoli & Isles		Rizzoli & Isles		(:03) Rizzoli & Isles		(:03) Rizzoli & Isles		(:01) Rizzoli & Isles		(:01) Rizzoli & Isles		(12:04) Rizzoli & Isles	
LIFEMOV	119	109	253	"Bad Nanny" (2022) Chelsea Rose Cook, April Hale.		"A Deadly Grudge" (2021) Annika Foster, Aubrey Reynolds.				(:01) "Bad Nanny" (2022) Chelsea Rose Cook, April Hale.				(12:01) "A Deadly Grudge"			
NBATV	273	156	216	NBA G League Basketball: Gold at Hustle		High Tops		Basketball Stories		Basketball Stories		Basketball Stories		Game of the Day			
PAR	34	241	241	**** "Forrest Gump" (1994) Tom Hanks. A slow-witted Southerner experiences 30 years of history.		**** "Forrest Gump" (1994) Tom Hanks. A slow-witted Southerner experiences 30 years of history.											
SYFY	59	122	244	(5:55) *** "Apollo 13" (1995, Historical Drama) Tom Hanks, Bill Paxton, Kevin Bacon.		(8:57) ** "XXX" (2002, Action) Vin Diesel, Asia Argento, Marton Csokas.		(:43) ** "XXX: State of the Union" (2005)									
TBS	33	139	247	Big Bang	Big Bang	Big Bang	Big Bang	Big Bang	Big Bang	Sheldon	Sheldon	Sheldon	Sheldon	George	George	George	George
TCM	169	132	256	**** "The Palm Beach Story" (1942)		(:45) *** "The Major and the Minor" (1942) Ray Milland		*** "Ball of Fire" (1941, Comedy) Gary Cooper.		*** "The Mad Miss Manton" (1938)							
TLC	45	183	280	1000-Lb. Sisters (N)		1000-Lb. Sisters (N)		I Am Jazz "Back to School"		Extreme Sisters		1000-Lb. Sisters		1000-Lb. Sisters		I Am Jazz "Back to School"	
TNT	32	138	245	NBA Basketball Washington Wizards at Atlanta Hawks.		NBA Basketball Minnesota Timberwolves at Los Angeles Clippers. (Live)		NBA on TNT Postgame		NBA Basketball: Wizards at Hawks							
TRAV	49	196	277	The Ghost Town Terror		The Ghost Town Terror		The Ghost Town Terror		The Ghost Town Terror		The Ghost Town Terror		The Ghost Town Terror		The Ghost Town Terror	
TRU TV	30	242	246	Inside Jokes	Inside Jokes	Inside Jokes	Inside Jokes	** "The Hangover Part III" (2013) Bradley Cooper.		** "The Hangover Part III" (2013) Bradley Cooper.				Inside Jokes	Inside Jokes	Inside Jokes	Inside Jokes
USA	31	105	242	WWE NXT (N) (Live)		(:08) Chicago P.D. "Memory"		(:08) Chicago P.D. (N)		(:08) Chicago P.D. (N)		(:08) Chicago P.D. (N)		(:08) Chicago P.D.		(12:08) Chicago P.D.	

tonight's picks



Alex Guarnaschelli

6 p.m. on FOOD
Chopped

The chefs are left a bit flummoxed by something fried in the appetizer basket, but they must power on in order to make it to the next round. Then, the competitive fire is strong in the entrée round as the chefs hustle to put together plates from a particularly strange combination of basket ingredients, including curious fusion tacos. But luckily, judges Alex Guarnaschelli, Marc Murphy, Amanda Freitag and Marcus Samuelsson are impressed when the chefs bring very different yet clear visions to the dessert table in the new episode "Gluten for Punishment." Ted Allen hosts.

8 p.m. on KTSM
La Brea

Gavin (Eoin Macken) leads his family toward a new way home, but each step inches everyone closer toward his devastating vision of Eve's (Natalie Zea) death. And with Levi (Nicholas Gonzalez) ostracized from the others, he is given a chance at redemption. Then, with Gavin on the verge of dying, Eve and her family make a desperate attempt to set things right. Elsewhere, Veronica (Lily Santiago) reveals a secret that sends her relationship with Lucas (Josh McKenzie) into jeopardy in the Season 2 finale "The Journey, Part 1." Part 2 immediately follows.

9 p.m. on KVIA
Will Trent

Abacadabra! Will (Ramon Rodriguez) discovers there is more than meets the eye to a case that comes across his desk and hits a little close to home. Meanwhile, Angie (Erika Christensen) and Ormewood (Jake McLaughlin) investigate a murdered magician while uncovering some extra tricks that had been up his sleeve in the new episode "Two Hundred Dollars and a Bus Pass." Iantha Richardson and Sonja Sohn also star.

12:15 a.m. on HBO
Movie: The King's Man

The third installment in the "Kingsman" movie franchise

and a prequel to the two earlier films, Matthew Vaughn's 2021 spy action comedy underperformed at the box office, mainly due to

pandemic-related issues. It still delivers an entertaining yarn about how the Kingsman organization was born during the turmoil of World War I.

DC DISTINGUISHED CHOICE
INSURANCE SOLUTIONS

MEDICARE HEALTH INSURANCE

Home/Nombre
JOHN L SMITH

Medicare Number/número de Medicare
1EG4-TE5-MK72

Entitled to/Con derecho a
HOSPITAL (PART A)
MEDICAL (PART B)

Coverage starts/Cobertura empieza
03-01-2016
03-01-2016

Contact your local Medicare broker!

- Medicare Supplements
- Medicare Advantage
- Medicare Part D

www.distinguishedchoice.com | 505.919.9720



CLARISSA "CLASSY" ACOSTA
CLARISSA172@GMAIL.COM

Always at your fingertips!

No login. No fees.

Check out the entire Bulletin in our weekly e-edition.

THE LAS CRUCES **Bulletin**

www.lascrucesbulletin.com

ACTIVE AGING



THE LAS CRUCES
Bulletin

Bulletin
HEAL+H

FEBRUARY 24, 2023

THE LAS CRUCES
Bulletin

Active Aging 2023 is a copyrighted special edition of the Las Cruces Bulletin, designed and published by Osteen Media Group, 1740-A Calle de Mercado, Las Cruces, NM 88005. Inquiries regarding editorial or advertising content may be directed to 575-524-8061.
© Copyright 2023
Las Cruces Bulletin

PUBLISHER
Richard Coltharp

EDITORIAL
Elva Österreich, Mike Cook

ADVERTISING
Jamila Khalil, Ad Manager
Michael Alderete, Eve Holguin
Zachary Simmons, Matthew Torres

DESIGN
Christy Anchondo

CIRCULATION
Beck Jimenez

Bulletin
HEALTH

One step at a time

Each piece makes a difference when it comes to heart health

BY ELVA K. ÖSTERREICH
Las Cruces Bulletin

MountainView Regional Medical Center's cardiothoracic surgeon Dr. Charles Dow said awareness is growing in communities and medical offices about heart health and coronary disease. The recognition that the presentation of heart problems is not only the typical known symptoms but can have other warning symptoms that need to be taken seriously.

"Because the typical symptoms of coronary disease, which is blockage of the arteries of the heart, in a woman may be different

than a man," he said. "A woman may not complain of the classic chest pain down your arm which is not necessarily that common. They may come in and complain of fatigue or shortness of breath maybe a pressure sensation or maybe just feeling a little bit different. Now clinical providers are realizing they may have heart disease."

Dow said maybe treatments haven't changed much but the process of best medical therapy has changed.

"I think the awareness and the prescription to instruct patients to take care of themselves better has made some dramati-

cal effects on care and is hopefully decreasing the incidence of heart disease," he said. "But it's still there, still the number one (killer of men and women in the United States)."

Dow said lifestyle changes can make all the difference and there are things individuals can control. He said the old adage "you are what you eat" is a big part of it, but there are others.

"We have learned stress plays a big role in heart disease," Dow said. "(things people can take care of include) the cessation of smoking; managing diabetes better; getting on the right medications to control blood pressure; taking charge of your health care; checking blood pressure, making sure it's not high all the time."

Dow said while all these things have helped prevent patients from suffering the ill effects of coronary disease, each one can make a difference by itself.

"If you take one thing out of this, stop smoking and you have just decreased your risk by a lot," he said. "If you don't smoke and you say, 'I'm going to try and eat better three times a week or walk 30-40 minutes three times a week or even just 20 minutes,' you have improved your heart health. Take one thing and say I'm going to focus on one thing at a time.

"What we can't do is



Dr. Charles Dow

change our genetic predisposition, but you can get close through management. Follow up; there are a lot of things we can do to control heart disease."

Dr. Craig Cannon and nurse practitioner (DNP)



Kimberly Miller work at the heart clinic at MountainView where they see about 50 patients a day. They must look at the patients referred to them, decide which ones are actually heart patients and determine a course of

actions for each.

Miller said heart disease is prevalent in this area where there is a lot of diabetes and other related things that lead to heart disease.

"We have a lot of disparity – poor diet, obesity – we are pretty packed (at the clinic) most of the time. It's a very busy business. Get potential problems treated early. If you leave it alone, you end up with heart failure and things that are very difficult to treat."

"Fifty percent of Americans will die of heart disease," Cannon said. "But there is a lot you can do on your own to help. Stay active and exercise, restrict your diet. Most heart disease is preventable."



I WILL HEAR BETTER THIS YEAR

The first step to better hearing?
Getting your hearing tested by some of the best in the business.

Call today for a complimentary hearing consultation and
free clean and check of your current hearing technology.
575.222.7373



**EXPERT
HEARING
CARE**

Doctors of Audiology | Celebrating 30 Years!

Las Cruces **Las Cruces**
4351 E Lohman Ave, Ste 103 1180 Mall Dr, Ste C



**2022
BEST OF THE
MESILLA VALLEY**
Las Cruces Sun News







Kelly Churchill, Au.D., CCC-A
Janine Granados, Au.D.
Allie Lambert, Au.D., CCC-A
Bo Martinez, Au.D.
Shelby Montano, Au.D., CCC-A

HearNM.com



CLEAN ENERGY FUTURE

BIG PLANS FOR CLEAN ENERGY

We want to do more to create a cleaner, brighter energy future for everyone. That's why we're working to achieve two major milestones that bring us closer to this goal:



Our investments in innovative energy infrastructure, EVs, and renewable energy developments are all part of the bold changes we're enacting today.

OUR ENERGY PORTFOLIO AT A GLANCE*

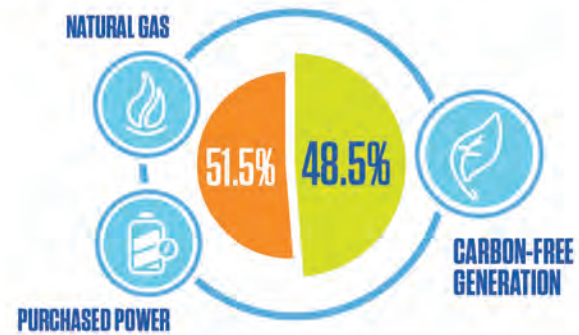

*2021 Generation Portfolio

**CO₂e contains carbon dioxide (CO₂), methane (CH₄), nitrous oxide (N₂O), and sulfur hexafluoride (SF₆)

A BRIGHT OUTLOOK FOR 2025

Expanding solar energy is key to building a brighter future for our region. That's why we're committed to making it more accessible and affordable for our customers every day.

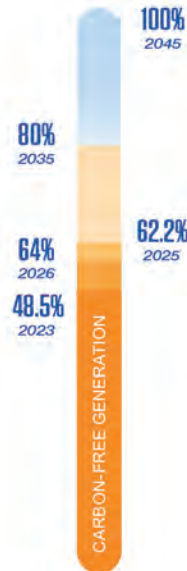

ELECTRIFYING A CLEANER FUTURE

We're committed to meeting our climate goals and inspiring others to take action. That's why we are accelerating the transition of our fleet to EVs, and supporting expansion of transportation electrification in our region!

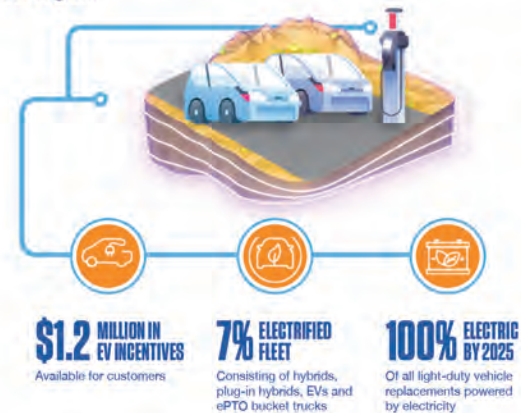

EL PASO ELECTRIC HAS A CLEAR PLAN TO A CLEAN ENERGY FUTURE!
epelectric.com/CleanEnergy



THE LAS CRUCES
Bulletin's Best
 OF THE Mesilla Valley
 ★ 2023 ★

Best of the Mesilla Valley

*Blue Horizon was voted
 Best Assisted Living in Las Cruces*



Blue Horizon
 Boutique Assisted Living & Memory Care

575-636-1142

bluehorizonmemorycare.com

2707 Spitz Ave.

OR (outdoor recreation) offers great opportunities for active aging

BY MIKE COOK

Las Cruces Bulletin

You would never know it to look at him, but Jim Glover is 65 years old.

Glover is an enthusiastic bicyclist and founder and co-director of endeavorOR New Mexico, an outdoor recreation (that's the capital OR in the name) business alliance based in Farmington.

Speaking at the Mesilla Valley Economic Development Alliance's (MVE-DA) Business in the New Mexico Borderplex forum at Hotel Encanto in Las Cruces in February, Glover and three other people representing national OR businesses and organizations touted the health and economic benefits of outdoor recreation.

If you hike, hunt, cycle (bi- or motor-), camp, kayak, raft, ski, fish, hang glide or view wildlife, you already know something about the almost unlimited OR opportunities that exist locally and all across New Mexico.

But you may not know just how impressive and important OR is in New Mexico.

"My passion right now is really working with the youth," Glover said.

Just one statistic was all Glover needed to make his point: Kids now spend seven to nine hours a day on digital devices and seven-nine minutes a day outdoors.

Part of endeavorOR's work is to help create a greater appreciation for OR among young people; connect them to mentors, apprenticeships and job opportunities; and just "get them outdoors where they can see their pathway to success," Glover said.

OR also presents tremendous economic opportunities for entrepreneurs, he said.

The No. 1 maker of backpacks in the United States is Osprey, Glover said, which found its home in tiny Cortez (population: 8,766) located in southwest Colorado, just above the New Mexico state line.

Smartwool, a very successful maker of

outdoor apparel, was founded in 1994 in Steamboat Springs in northwest Colorado, which has a population of less than 14,000 people, Glover said.

"It doesn't really matter the size of your community," he said.

"When people get outside, really good things happen," Outdoor Recreation Roundtable Senior Director Chris Perkins said at the forum. "We support local economies."

Nationally, OR generated \$365 billion in 2021, and \$2.2 billion in New Mexico, where it has created more than 30,000 jobs.

Rebecca Gillis, state and local government affairs manager for the Outdoor Industry Association,

said OR businesses not only provide jobs and "outdoor access to all," they are good stewards of natural resources.

"We believe the outdoors is a fundamental human right," said Tom Bugert, state and local government affairs manager for Recreation Equipment, Inc. (REI), a cooperative based in Seattle.

One of REI's goals is to grow outdoor advocacy and give its advocates a louder voice, Bugert said.

"On a national level, people are really looking into New Mexico," Glover said.

He touted the annual New Mexico Outdoor Economics Conference, which was started by state Sen. Jeff Steinborn of Las Cruces in 2018, as "a world class affair."

The 2022 conference, held in Taos, drew more than 350 attendees from across the state, said Steinborn, whose 2015 legislation created the Rio Grande Trail Commission to oversee the development of a 500-mile recreation trail running the entire north-south length of the state. Steinborn also sponsored legislation in 2019 that created the New Mexico Economic Development Department's Outdoor Recreation Division.

"We're getting there," Glover said.

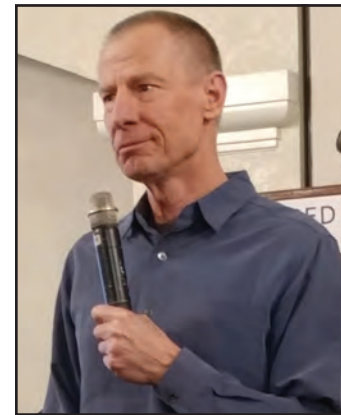

Jim Glover

Homes ★ Land ★ Investment ★ Commercial ★ Multi-Family ★ Development ★ 1031 Exchange

Buying Real Estate?
Selling Real Estate?
FREE PROFESSIONAL
CONSULTATION

CELL: 575-644-7254
Se Habla Español
euranga@international1realtor.com



www.ErnestoUranga.com

Ernesto
URANGA



I can guide you towards making the best informed Real Estate decision based on my experience as a Professional Real Estate Broker in the Las Cruces Doña Ana County New Mexico Area.



SRES[®] SENIOR REAL ESTATE SPECIALIST

39 years helping clients in Las Cruces Doña Ana NM



What you need to know.
What to plan for.
What to do along the way.

Real world solutions addressing questions that arise in the various stages of dementia and Alzheimer's disease.

REGISTER NOW FOR THESE FREE PROGRAMS:

****Caring in the Early Stage**** | ****Caring in the Middle Stage**** | ****Caring in the Late Stage****



nmprograms@alz.org
575-647-3868



New Mexico Chapter



"My mom was very pleased with the care given to her... I have never heard medical professionals speak in such loving ways to their patients. I highly recommend this facility. Thank you for making my mom strong and mobile again." -Patti

Certified by The Joint Commission

- Stroke, Spinal Cord Injury, and Brain Injury

Top 10% in the Nation

- UDSMR - 14 years in a row

- Daily Physician Supervision
- Customized Intensive Therapy Program
- Outpatient Rehabilitation



RHSNM.ERNESTHEALTH.COM

4441 East Lohman Avenue • Las Cruces, NM 88011
ph: 575.521.6400 • fax: 575.521.6423



"Words are insufficient to express the gratitude that Bob and I feel for all the tender, loving care that I received during my stay." - Helen

Certified by The Joint Commission

- Respiratory Failure

- Daily Physician Supervision
- Comprehensive Rehabilitation Program
- Ventilator Weaning Program

We are passionate patient caregivers.



ACHSNM.ERNESTHEALTH.COM

4451 E Lohman Ave • Las Cruces, NM 88011
ph: 575.521.6600 • fax: 575.532.5077

Dancing: Light on the feet, heavy on the fun

BY RICHARD COLTHARP

Las Cruces Bulletin

It's not called smile therapy, but ballroom dancing classes may just be the same thing.

At a recent group lesson at SOL Ballroom Dance Center, everyone in the building sported a big grin even before instructor and Sol's founder, Hannah Cole, shouted her encouragement: "Smile! Show your teeth!"

Dave Clements and his wife, Janet, have been dancing together for 17 years, and are regulars at Sol.

"We don't just do it to be fit, although it helps with that," said Clements, who is 82. "But it's also fun, and very satisfying for me and my wife. It's greatly enhanced the romanticism in our marriage."

"Most people, most days, do three things: walk, stand and sit," Cole said. "So we lose the ability to use a lot of muscles."

Dancing, particularly with a partner, Cole said, brings many different muscles

into play, not to mention your brain cells.

"All movement is good," Cole said.

"Even just standing on one leg will open new neural pathways. But in partner dancing there are so many different elements. You'll go from high impact to slow and sustained. You're using your body in different ways, and that's what our body likes. The movement of your hands, especially above your heart, is good for cleansing your body."

Cole also cites studies from the Albert Einstein College of Medicine that have shown the benefits of dancing for keeping the brain sharp as people age. The College's website, citing a recently published paper, said, "... social dancing may be a safe, enjoyable, and effective alternative to traditional physical exercise for preventing cognitive decline and reducing risk for Alzheimer's disease."

"Running or jogging doesn't have the mental components," Cole said. "Even dancing by yourself doesn't have the mental components of patterns, navigating the



PHOTOS BY TABITHA ROSSMAN

floor, connecting with your partner, having to make snap decisions in an analytical way and choose responses. In no other physical activity do you do all that. And at the same time, you're listening to music, which engages your emotions."

There are also social benefits both during classes and after, when people use their new skills out in the world, whether it's at a small family wedding or a big nightclub dance floor.

"As we age, that loneliness factor can really set in," Cole said. "But 45 minutes of dancing really does change your mental state. With depression and anxiety, dancing just makes such a difference. It gives you something to look forward to, a place to belong."

Often as not, people come to dance lessons by themselves instead of as a couple. They quickly make friends with other students, Cole said, and many learn things about themselves they never knew.

"The self-expression is beautiful," Cole said. "It's wonderful for someone who does that thing just for herself."

George Moscona, 80, has been dancing most of his life, so already knows most of the steps, but loves coming to Sol.

"I really enjoy the socializing, and being included in such an inclusive environment," Moscona said.

Julia is a student who takes lessons to help her progress and heal from a series of injuries and issues that left her "broken,



broken and broken." Each lesson reduces her reliability on using a walker. But she likes another thing about SOL, telling Cole one day: "I just came for my afternoon hug!"

SOL's youngest student is 4, and there are a few in their 80s, and just about every age in between is represented.

"We have a lot of college kids spending Every Other Friday Night (a special dance party program) here," Cole said. "What better way to spend a Friday night than to dance and burn a thousand calories?"

Cole, originally from California, has



575-437-2202
1110 New York Ave.
Alamogordo NM 88310
www.flickingercenter.com

UPCOMING EVENTS

ALAMOGORDO MUSIC THEATRE PRESENTS

GREASE

MARCH 10, 11, 17, 18 @ 7PM
MARCH 12 @ 2PM

SPONSORED BY: BANK 34

MADS TOLLING
AND the MADS MEN
MAR 31 @ 7PM

THRIVE
Presents
RICOCHE
A BENEFIT CONCERT
MARCH 25TH | 7:00PM

25+ YEARS OF HITS
1 GOLD ALBUM
2 NUMBER ONES
3 TOP TENS
6 TOP 40 HITS

State St BALLET
THE JUNGLE BOOK
APRIL 11 • 7PM

SPONSORED BY BURET BROADCASTING, INC & 94 KTYE



PHOTO BY TABITHA ROSSMAN

DANCING | from 7

been teaching dance for 30 years. She competed professionally for several years, and came to Las Cruces in 2012 to work with the New Mexico State University DanceSport program. Many may know her from her involvement with the fundraiser “Look Who’s Dancing.”

SOL has three ballroom instructors and a ballet instructor, and Cole is always looking at new ways to serve the community. One possible future class she’s considering is hip-hop for adults.

SOL, which Cole opened in January 2019, offers a variety of opportunities for dancers and would-be dancers.

- Individualized classes by appointment

(for singles or couples)

- Social dance series (eight weeks featuring eight different dances; for singles or couples)
- Adult group lessons (coming soon)
- Every Other Friday Night SOL Dance Party (one hour of group instruction followed by a two-hour dance party)
- Chair class (for people unable to do full dance, a chance to develop flexibility and mobility and perhaps graduate to full dance)

SOL Ballroom Dance Center is at 200 S. Solano Drive, Suite 1. Contact the studio at dance@solballroom.com or 575-288-1113, or visit solballroom.com.

Mesilla Valley Pharmacy

LAS CRUCES'S FAVORITE PHARMACY 2 YEARS IN A ROW



A BETTER PHARMACY EXPERIENCE

227 S Main St. Las Cruces, NM 88001
Phone: 575-323-2093
www.mvprx.care

FEBRUARY IS



Heart Health
Month

Lookman Lawal, MD, FACC, FHRS

Board Certified Electrophysiologist
and Cardiologist

Director, Southwestern Cardiac
Arrhythmia Institute



Did you know that:

- Atrial fibrillation is the most common heart rhythm disorder?
- It is a leading cause of stroke.
- Some people are unaware they have atrial fibrillation until it's too late.
- Sleep apnea is a leading risk factor for atrial fibrillation.
- Atrial fibrillation can be **easily diagnosed and treated.**
- At Southwestern Cardiac Arrhythmia Institute, **we specialize in the treatment of atrial fibrillation.**

We bring state-of-the-art technology to individuals with heart rhythm disorders.



Southwestern Cardiac
Arrhythmia Institute
4351 East Lohman Avenue, Suite 204
Las Cruces, New Mexico 88011
Tel: 575 496 5725
www.southwesternheart.com

ASC of the Heart Institute
1250 N. Sonoma Ranch Blvd.
Las Cruces, NM
Tel: 575 323 3010
www.ascheart.com



Providing every patient with compassionate and personalized care.

Pets can help you stay active

BY MIKE COOK

Las Cruces Bulletin

“Having pets is a great way to stay active and engaged as we age,” said ACTION Programs for Animals (APA) Executive Director Michel Meunier. “Studies have shown it keeps us healthier, too, and helps us fight loneliness and depression. At APA, we offer seniors adoption specials and help match them to companions that match their particular lifestyles – active or not so active.”

“For those who cannot adopt or are on the fence about it, APA has two programs that allow you to take a dog (and sometimes even a cat) for a sleepover or Doggy Day Out,” Meunier said. “With the former, you can take an animal home for a week or longer to see if it might work out before you commit to adoption. With the latter,

you can take a dog out for a walk, a drive, a hike or just a visit to your home for the day or a few days.”

“We have many senior adopters, Meunier said. “One recent PAWS (Prisoners and Animals Working Toward Success program) trained dog, Alaska, went home with two senior ladies.”

Since May 2012, APA has rescued more than 5,500 animals.

To meet APA’s adoptable animals, visit the adoption center at 537 N. Solano Drive 11 a.m.-3 p.m. Tuesday, Wednesday, Thursday or Saturday, or call 575-571-4654 to schedule an appointment. Adoptable animals may also be viewed at apalascruces.org.

Also visit the Animal Services Center of the Mesilla Valley website at <https://ascmv.org/>.



ACTION Programs for Animals offers seniors adoption specials. Adoptable animals may be viewed at apalascruces.org.



PHOTOS COURTESY OF MICHEL MEUNIER, ACTION PROGRAMS FOR ANIMALS



Let me find the perfect retirement home for your lifestyle!

TRUST PROPERTIES
RentinLC.com

Angela Potter
Qualifying Broker Lic# 18483.
Eviction Services,
Property Management,
Investment Consultants
and more.

forrentinlascruces.com • (575) 312-1593

We go the extra mile!

Dr. Lauren Reyes and Pete Reyes would like to welcome **Dr. Cassandra Hoisington** to the practice!

Dr. Hoisington will be joining the practice as a full partner February 1st, when we will expand our hours and services!

ZIA MOBILE VET
405-808-8769

Thank you for trusting us with your pets!

ZIAMOBILEVET.COM

The City of Las Cruces offers recreation, meals, volunteer opportunities

BY MIKE COOK

Las Cruces Bulletin

Billiards? Bingo? Horseshoes? The City of Las Cruces has multiple programs and services designed for people who are age 50 and over. Choices also include ceramics, painting, crocheting, chess ballroom dance classes, writing, mosaics, gourd painting, stained glass, learning to speak Spanish, karaoke, mah jongg, line dancing and more. The city also offers a vast number of volunteer opportunities.

You can also participate in adult sports programs like hiking, biking, walking and fitness classes that are coordinated by the City of Las Cruces Parks and Recreation Department.

Meals on Wheels

The city's Meals on Wheels program is for the homebound, those lacking a family support system, people unable to obtain or prepare a nutritious meal or unable to participate in the city's congregate meal program because of an impairment or lack of transportation. The suggested donation for home-delivered meals is \$3 for both a cold breakfast and a noon meal.

Call 575-541-2031. Call the meal reservation line at 575-528-3012. Call city senior transportation at 575-541-2777.



PHOTO BY ELVA K. ÖSTERREICH

Food 4 Paws

The city offers free pet food assistance for seniors. It is available 11 a.m.-12:30 p.m. every other Wednesday (including March 1 and 15) at Eastside Community Center, 310 N. Tornillo St. Call 575-528-3013. Visit www.lascruces.gov/2578/Food-4-Paws, which has a calendar of events that includes Food for Paws – click on the “SHOW MORE” icon for each day to show all items available that day.

Volunteer

The city's volunteer network provides more than 350 volunteers to 39 sites in the city, including cultural sites, senior programs, city departments, the Animal Service Center of the Mesilla Valley, youth sports programs and the alert citizen program.

There are also many city boards, commissions and committees that need active volunteer members. Visit the get-involved web page listed below for links to volunteer positions and city boards, commissions and committees.

For more information, call 575-528-3035, visit Munson Senior Center, 975 S. Mesquite St. and visit www.lascruces.gov/1749/Volunteer-Network and www.lascruces.gov/218/Get-Involved.

SENIOR PROGRAMS AND SENIOR CENTERS

The city's Senior Programs offers lunch and recreation programs at

- **Munson Senior Center**, 975 S. Mesquite St., 575-528-3000, open 8 a.m.-5 p.m. Monday-Friday. This is the city's flagship senior center. It offers dine-in meal service; Meals-on-Wheels intake and evaluations; a community garden, a public park with exercise equipment; a computer lounge; and these recreation programs: billiards, lapidary workshop, dances, classes, fitness more.

- **East Side Center**, 310 N. Tornillo St., 575-528-3012, open 8 a.m.-2 p.m. Monday-Friday. This is the hub for the city's nutrition program and Meals on Wheels program. In addition to dine-in meal service, it offers billiards, landscape painting, woodcarving, crochet, card and board games and dances.

- **Henry Benavidez Community Center**, 1045 McClure Road, 575-541-2005, open 10 a.m.-2 p.m. Monday-Friday. In addition to dine-in meal service, it offers bingo, dances, an AARP fit lot and a public park with jungle gym.

- **Sage Café Senior Center**, 6121 Reynolds Drive, 575-528-3151, open 9 a.m.-2 p.m. Monday-Friday. In addition to dine-in meal service, it has a branch of Thomas Branigan Memorial Library on site.

- **Frank O'Brien Papen Center**, 304 Bell Ave., 575-541-2455, open 8 a.m.-5 p.m. Monday-Friday. Grab-and-go food pick up is available 11 a.m.-12:30 p.m. The center offers a wide range of recreation programs and activities.

Visit www.lascruces.gov/2583/Senior-Centers, www.lascruces.gov/1688/Senior-Program and www.lascruces.gov/1723/Recreation-Programs (which includes a calendar of events).

Affordable Insurance is Within Your Reach



GATEWAY SENIOR SOLUTIONS

gateway seniorsolutions@outlook.com

2104 E. Yandell Dr. Ste #2 - El Paso, Texas

915-228-4866

Brian Weeden

VETERAN-OWNED BUSINESS

Family & Veteran Owned Business!



NATURALLY LEAVENED BREAD & PASTRIES

201 S. SOLANO DR. STE G
LAS CRUCES, NM 88001

575-993-1560

Tues-Fri: 7am-6pm
Sat: 7am-2pm

KIND BREAD COMPANY

WALK-INS WELCOME!



We Have Your Windows Covered!



Since 1976

Call us to schedule an appointment to visit our showroom and view our wide selection of window coverings, draperies, bedding and custom furniture.

2310 N. Temple • (575) 526-2880 • springcrestnm.com



Antiques, Collectibles, Furniture, Jewelry, Gifts

Furniture Donations Always Welcome!

DONATE SHOP SUPPORT

Mesilla Valley Hospice

106 S. Water St. • 575-523-8078 • emporiumlc.com

Tues-Fri 10am-4pm, Sat 10am-2pm

Save time and money by making your payment online!



Call your local office to find out more!

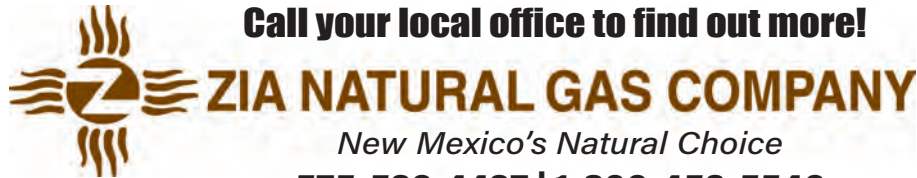

New Mexico's Natural Choice

575-526-4427 | 1-800-453-5546

3700 W. Picacho Ave., Las Cruces

ZNGC.COM

Proudly Serving Colfax, Dona Ana, Lea and Lincoln Counties

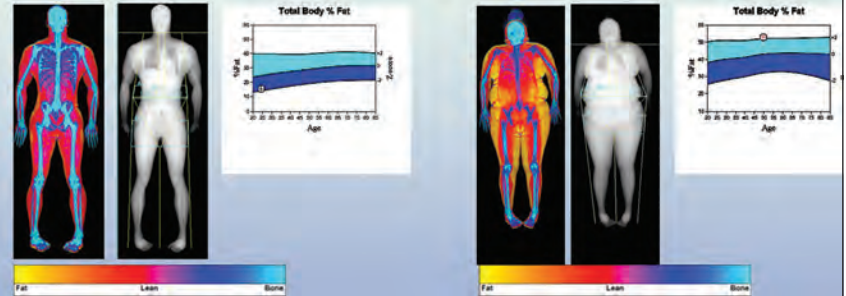

DUAL-ENERGY ABSORPTIOMETRY GOLD STANDARD
LEAN MASS FAT MASS VISCERAL FAT SKELETAL HEALTH

DEXA

99% ACCURATE ESTABLISH A BASELINE
 GET A COMPREHENSIVE REPORT WITH NO GUESSING

VO2 MAX

VOLUME, OXYGEN, MAX RATE AEROBIC CAPACITY
 NO MORE CRUDE ESTIMATES
 FIND YOUR PRECISE ESTIMATE OF EXERCISE INTENSITY
 CARDIOPULMONARY CAPACITY

*-Reliable Health and Longevity Indicator
 -Factors Health Risks
 (such as tobacco use, blood pressure, cholesterol)*

RMR

RESTING METABOLIC RATE MEDICAL GRADE TESTING ANALYSIS
 SIGNIFICANTLY MORE ACCURATE VS USING AN EQUATION
 A HIGHLY UNIQUE AND IMPORTANT NUMBER

RMR ACCOUNTS FOR ABOUT 70% OF ALL ENERGY YOUR BODY CAN UTILIZE

OPEN STANDING MRI X-RAY DEXA VO2MAX RMR



CALL US FOR MORE INFORMATION AT 575-259-3069



Salud Healthcare

Stay Moving, Stay Functional!



Ultrasound-Guided Joint Injections
 For precise placement of medication



Cell Therapy Injections
 Promotes natural repair response



Trigger Point Injections
 Decrease musculoskeletal pain



Protein Rich Plasma Injections
 Boost your own healing properties



Peptide Therapy
 Targeted amino acid therapy for a variety of health concerns



📍 1300 El Paseo Rd #244
 Las Cruces, NM 88001

📞 (575) 218-7742

🌐 www.saludhealthcare.net

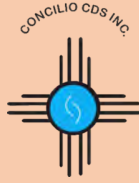

Concilio CDS Inc.

"Making a Difference in Our Community"

Concilio CDS Inc. (Concilio Campesino Del Sudoeste) is a 501(c)3 private community based, state-wide not-for-profit organization that began in 1972



Educate
TimeBanking

Senior Volunteers
CAREGIVING & RESPITE
Support & Share
Promotores

Safe Volunteering
Making Smiles Every Day
Health Promotion
Mentoring

Contact our offices at:

2220 S. Solano Dr.
Las Cruces, NM 88001
(575) 521-9814

104B E. Aztec Ave
Gallup, NM 87301
(505) 399-5019

2610 N. Silver St.
Silver City, NM 88061
(575) 388-2522

WWW.CONCILIOCDSINC.ORG



What's Available **NOW** On **NETFLIX**



“Movie: We Have a Ghost”

Christopher Landon (“Paranormal Activity: The Marked Ones”) directed this horror comedy about a family who become social media sensations when they discover a ghost named Ernest (David Harbour, “Stranger Things”). But when young Kevin (Jahi Di’Allo Winston) helps the spirit investigate the mystery of his past, they attract the attention of the CIA. Anthony Mackie, Jennifer Coolidge and Tig Notaro also star. (ORIGINAL)



“Community Squad”

This Argentine comedy series follows an urban civilian patrol squad created as a marketing ploy to improve the image of the police, who inadvertently put their lives at risk when they stumble upon an unusual gang of criminals. Santiago Korovsky, Daniel Hendler and Pilar Gamboa head the cast. (ORIGINAL)



“In Love All Over Again”

From Spain comes this romantic comedy series about Irene (Georgina Amorós, “Elite”), a young film student who comes to Madrid hoping to make her name as a director. There she meets Julio (Franco Masini, “Riviera”), who would be the perfect lead role for her films and her life — if only life didn’t have other ideas. (ORIGINAL)



“Cheat”

From the United Kingdom comes this high-stakes quiz show in which contestants can win up to a 50,000 pound grand prize by bluffing their way through three rounds of questions. The trick is to not get caught in their lies. Danny Dyer and Ellie Taylor are the hosts. (ORIGINAL)

Las Cruces' Premium Cigar Lounge
CIGARS • PIPES • TOBACCO & MORE
2460 S. Locust ~ Las Cruces ~575-571-4199

Unwind
casadetobaccocigar.com

BECOME A DIAMOND MEMBER! \$130/month
•\$30 Gift Card Every Month •20% Off Cigars •15% Off Accessories
•50% Off Mixers • Free Water and Coffee • Locker for Personal Use

NOW OPEN!

Sage Spices

RUBS, BLENDS, OILS, VINEGARS, COMFORT FOODS
Happy New Year
Sampling Cheese & Sausage
300 N. Main Suite 5- In "The Courtyard"

DESERT
exposure

Monthly in Southern New Mexico:
“The biggest little newspaper in the Southwest”

575-524-8061
www.desertexposure.com

SAINT Patrick's DAY

Amador LIVE

March 17th | Gates open @ 4 PM
G/A Tickets \$15 at the Gates
VIP PATIO & RINGSIDE TABLES
CALL FOR RESERVATIONS
575-541-7417
302 S. Main St. Las Cruces, NM 88001

MIDGET WRESTLING WARRIORS

WEDNESDAY EVENING

S - Spectrum D - Dish DTV - DirecTV

MOVIES

SPORTS

SPECIALS

MARCH 1, 2023

	S	D	DTV	6 PM	6:30	7 PM	7:30	8 PM	8:30	9 PM	9:30	10 PM	10:30	11 PM	11:30	12 AM	12:30	
PBS-KRWG	2	22	22	NewsHour	News 22	American Masters Dick Cavett and Groucho Marx.			Peter Frampton at Royal Albert Hall	The Carpenters: Close to You-My Music			PBS NewsHour					
CBS-KDBC	3	4	4	Jeopardy! (N)	Wheel	Survivor (Season Premiere) Castaways compete in Fiji. (N)			True Lies "Pilot"	CBS4 News			Late Show-Colbert	James Corden	Paid Program			
ABC-KVIA	7	7	7	News	Ent. Tonight	The Conners	Goldbergs	Abbott Elem	Not Dead Yet	A Million Little Things (N)	News	(:35) Jimmy Kimmel Live!		(:37) Nightline		Ent. Tonight	Hollywood	
FOX-KFOX	8	14	14	Big Bang	Big Bang	The Masked Singer (N)			Special Forces-Toughest	KFOX News at Nine (N)		Mod Fam	Mod Fam	iCRIME	Simpsons	Two Men	Two Men	
NBC-KTSM	9	9	9	KTSM 9 News at 6 (N)	Chicago Med (N)	Chicago Fire (N)			Chicago P.D. (N)	KTSM News			Tonight Show-J. Fallon		Late Night With Seth Meyers		(:37) TMZ (N)	
UNI-KINT	10	-	26	La rosa de Guadalupe	Perdona nuestros pecados	Mi camino es amarte (N)			Cabo (N)	Noticiero Uni.			Noticiero	Contacto deportivo (N) (Live)		Mi camino es amarte		
TEL-KTDO	11	48	48	La casa de los famosos (N)	El señor de los cielos (N)	Amor y traición (N)			Noticiero	Noticias			Caso cerrado		Enemigo íntimo			
UMAS-KTFN	13	7593	65	¡Siéntese quien pueda! (N)	(6:58) Enamorándonos (N) (Live)	Resistiré (N)			Como dice el dicho (N)			¡Siéntese quien pueda!		Resistiré				
CW-KVIA2	14	17	8	Sheldon	Sheldon	The Flash (N)			Kung Fu "Loss" (N)	Seinfeld	Seinfeld	Sheldon	Neighbor	Last-Standing 25 Words	Pawn Stars	Storage Wars		
A&E	43	118	265	The First 48			The First 48			(:01) The First 48			(:03) The First 48			(:12:04) The First 48		
AMC	57	131	254	** "Con Air" (1997) Nicolas Cage. Vicious convicts hijack their flight.			*** "The Fugitive" (1993, Action) Harrison Ford, Tommy Lee Jones, Sela Ward.			Fear the Walking Dead			Fear Walking					
COMEDY	35	107	249	South Park	South Park	South Park	South Park	South Park	South Park	The Coon Trilogy"			South Park	South Park	South Park	Mike Judge's	Daily Show	South Park
COOK	123	113	232	Best Thing	Best Thing	Best Thing	Best Thing	Food Paradise	Food Paradise "Dipped"	Best Thing	Best Thing	Best Thing	Best Thing	Best Thing	Best Thing	Food Paradise		
DSC	47	182	278	Moonshiners A legendary Franklin County moonshine. (N)			Moonshiners: Double Shot			Master Distiller			Moonshiners A legendary Franklin County moonshine.			Moonshiners: Double Shot		
E!	37	114	236	Sex-City	Sex-City	Sex-City			To Be Announced			To Be Announced			E! News (N) Royal			
ESPN	27	140	206	NBA Basketball Cleveland Cavaliers at Boston Celtics.			NBA Basketball New Orleans Pelicans at Portland Trail Blazers. (Live)			SportsCenter W/Van Pelt			SportsCenter W/Van Pelt			SportsCenter		
FOOD	40	110	231	Guy's Grocery Games			Guy's Grocery Games (N)			Guy's Grocery Games			Guy's Grocery Games			Guy's Grocery Games		
FX	29	136	248	(5:30) ** "Man on Fire" (2004) Denzel Washington, Dakota Fanning.			*** "Thor" (2011, Action) Chris Hemsworth, Natalie Portman.			Snowfall (N)			Snowfall					
GALA	25	273	404	Una familia de diez (N)			Nosotros los guapos (N)			Vecinos (N)	40 y 20	40 y 20	Renta	Renta	Alma de	Alma de	Simón dice	Simón dice
GOLF	24	401	218	College Golf	Golf Central	LPGA Tour Golf HSBC Women's World Championship, First Round. (Live)			LPGA Golf									
HALL	58	185	312	"Welcome to Valentine" (2023) Kathryn Davis.			Golden Girls	Golden Girls	Golden Girls	Golden Girls	Golden Girls	Golden Girls	Frasier	Frasier	Frasier	Frasier		
HGTV	41	112	229	Property Brothers			Nate & Jeremiah	Hunters	Hunters	Nate & Jeremiah	Nate & Jeremiah	Hunters	Hunters	Nate & Jeremiah				
HISTORY	44	120	269	American Pickers (N)			American Pickers (N)			Dirty Old	Dirty Old	(:03) American Pickers	(:03) American Pickers	(:05) American Pickers	(12:04) American Pickers			
LIFE	39	108	252	Married at First Sight "Party-ing Ways" (N)			(:03) Married at First Sight UK			(:33) Married at First Sight			(:29) Married at First Sight "Party-ing Ways"		Married-UK			
LIFEMOV	119	109	253	"Obsession: Escaping My Ex" (2020) Celeste Desjardins.			"Obsession: Her Final Vengeance" (2020, Suspense)			(:01) "Obsession: Escaping My Ex" (2020) Travis Nelson			"Obsession-Final"					
NBATV	273	156	216	(5:00) NBA GameTime			NBA GameTime			NBA Game			NBA Game		NBA Game	NBA Game		
PAR	34	241	241	*** "The Blind Side" (2009, Drama) Sandra Bullock, Tim McGraw, Quinton Aaron.			*** "The Blind Side" (2009, Drama) Sandra Bullock, Tim McGraw, Quinton Aaron.			Movie								
SYFY	59	122	244	(5:30) ** "The Day After Tomorrow" (2004, Action)			The Ark (N)			The Twilight Zone (N)			*** "Minority Report" (2002, Science Fiction) Tom Cruise, Colin Farrell.					
TBS	33	139	247	All Elite Wrestling: Dynamite (N) (Live)			Power Slap: Road to Title			Sheldon	Sheldon	Sheldon	Sheldon	George	George	George	George	
TCM	169	132	256	**** "The Adventures of Robin Hood" (1938)			**** "The African Queen" (1951) Humphrey Bogart.			**** "The Man Who Would Be King" (1975)			"Mutiny on the Bounty"					
TLC	45	183	280	My 600-Lb. Life Mark turns down medical advice. (N)			1000-Lb. Best Friends (N)			1000-Lb. Sisters			My 600-Lb. Life Mark turns down medical advice.			1000-Lb. Best Friends		
TNT	32	138	245	NHL Hockey New York Rangers at Philadelphia Flyers.			NHL Hockey Carolina Hurricanes at Vegas Golden Knights. (Live)			NHL on TNT			NCIS: New Orleans		NCIS: New Orleans			
TRAV	49	196	277	Paranormal Caught Camera			Paranormal Caught Camera			Paranormal Caught Camera			Paranormal Caught Camera			Paranormal Caught Camera		
TRU TV	30	242	246	Inside Jokes	Inside Jokes	Inside Jokes	Inside Jokes	Imp. Jokers	Imp. Jokers	Imp. Jokers	Imp. Jokers	Inside Jokes	Inside Jokes	Inside Jokes	Inside Jokes	Inside Jokes	Inside Jokes	
USA	31	105	242	Law & Order: SVU			Law & Order: SVU			Law & Order: SVU			Law & Order: SVU			Law & Order: SVU		

tonight's picks

7 p.m. on KDBC
SurvivorIt seems like yesterday
that Richard Hatch won thevery first "Survivor" with a
unique mixture of grit and
nudity. Luckily, we've come
a long way as the Season 44
premiere has a perfect mixtureof brains, brawn and bravado.
From a former NFL player to
a NASA engineering student,
18 strangers test themselves
against the elements, the
challenges and each other to
see who can hold on to win
the \$1 million prize. Jeff Probst
hosts.8 p.m. on KVIA
Abbott ElementaryJacob (Chris Perfetti) secures
a visit from a mural arts
program for his students
but doesn't agree with their
chosen design and attempts
to influence their decision in
another direction. Meanwhile,
Barbara (Sheryl Lee Ralph)
and Melissa (Lisa Ann Walter)
learn parents are petitioning
to turn Abbott into a
Legendary charter school in
the new episode "Mural Arts." Quinta
Brunson, Janelle James and
Tyler James Williams also star.8 p.m. on BET
The Wine Down With Mary
J. BligeIf you like real talk, Mary
J. Blige and wine, this is
the show for you. This new
series will bring together the
hottest, most outspoken,
highly sought-after people in
entertainment, sports, social
media, and politics for raw,

Chris Perfetti

provocative, insightful and
real conversations over wine,
with Blige as host. And, if you
weren't aware, she has her
own wine label, Sun Goddess,
with Italian winemaker Marco
Fantinel. Pour yourself a glass
and join the conversation.9 p.m. on KDBC
True LiesInspired by James Cameron's
hit action/comedy film of
the same name, this series
premiere follows Harry
Tasker (Steve Howey), afirst-class international spy
for U.S. intelligence agency
Omega Sector, and his wife,
Helen (Ginger Gonzaga), a
language professor bored
with her daily routine, who is
shocked to discover that her
seemingly dull husband is
leading a double life. Omega
recruits Helen, who impresses
everyone with her formidable
skills (thanks to Tae Bo and
yoga), and the duo embark
on covert missions around the
globe.

**CHOOSE A ROOFING CONTRACTOR
WHO GOES ABOVE AND BEYOND!**

**Serving Residential and Commercial Las Cruces
and Outlying Areas Since 2011**

575.288.5615

<https://anthonyosaroofing.com>

THURSDAY EVENING			S - Spectrum D - Dish DTV - DirecTV										MOVIES	SPORTS	SPECIALS	MARCH 2, 2023	
S	D	DTV	6 PM	6:30	7 PM	7:30	8 PM	8:30	9 PM	9:30	10 PM	10:30	11 PM	11:30	12 AM	12:30	
PBS-KRWG	2	22	22	NewsHour	News 22	The Carpenters: Close to You-My Music		Elvis Presley: '68 Comeback Special			The Seven Ages Of Elvis The legacy of Elvis Presley.					PBS NewsHour	
CBS-KDBC	3	4	4	Jeopardy! (N)	Wheel	Sheldon	Ghosts (N)	So Help Me Todd	CSI: Vegas "Ashes, Ashes"	CBS4 News	Late Show-Colbert		James Corden			Paid Program	
ABC-KVIA	7	7	7	News	Ent. Tonight	Station 19 "I Know a Place"	Grey's Anatomy "All Star"		(:01) Alaska Daily (N)	News	(:35) Jimmy Kimmel Live!	(:37) Nightline	Ent. Tonight	Hollywood			
FOX-KFOX	8	14	14	Big Bang	Big Bang	Next Level Chef (N)	Animal	Call Me Kat	KFOX News at Nine (N)	Mod Fam	Mod Fam	iCRIME	Simpsons	Two Men	Two Men		
NBC-KTSM	9	9	9	KTSM 9 News at 6 (N)	Law & Order "12 Seconds"	Law & Order: SVU	Law & Order: SVU	Law & Order: Organized	KTSM News	Tonight Show-J. Fallon	Late Night With Seth Meyers	(:37) TMZ (N)					
UNI-KINT	10	-	26	La rosa de Guadalupe (N)	Perdona nuestros pecados	Mi camino es amarte (N)			Cabo (N)	Noticiero Uni.	Noticiero	Contacto deportivo (N) (Live)	Mi camino es amarte				
TEL-KTDO	11	48	48	La casa de los famosos (N)		El señor de los cielos (N)			Amor y traición (N)	Noticiero Telemundo 48	Caso cerrado		Enemigo íntimo				
UMAS-KTFN	13	7593	65	¡Siéntese quien pueda! (N)	(6:58) Enamorándonos (N) (Live)				Resistiré (N)	Como dice el dicho (N)	¡Siéntese quien pueda!	Resistiré					
CW-KVIA2	14	17	8	Sheldon	Sheldon	Walker "The Deserters" (N)	Walker Independence		Seinfeld	Seinfeld	Sheldon	Neighbor	Last-Standing / 25 Words	Pawn Stars	Storage Wars		
A&E	43	118	265	The First 48	Accused: Guilty	(:01) Undercover Life Pilot			(:04) The First 48	(:03) The First 48	Accused: Guilty	(12:04) Undercover Life Pilot					
AMC	57	131	254	** "Hitman" (2007) Timothy Olyphant, Dougray Scott.	** "Hitman: Agent 47" (2015) Rupert Friend. Premiere.				(:15) **** "Pulp Fiction" (1994, Crime Drama) John Travolta, Samuel L. Jackson.								
COMEDY	35	107	249	The Office	The Office	The Office	The Office	The Office	The Office	The Office	The Office	The Office	The Office	The Office	Daily Show	Mike Judge's	
COOK	123	113	232	Delicious	Delicious	Delicious	Delicious	Brew & 'Que	Brew & 'Que	Brew & 'Que	Brew & 'Que	Delicious	Delicious	Delicious	Brew & 'Que	Brew & 'Que	
DSC	47	182	278	BattleBots "You Want a Pizza Me?" End Game and HyperShock. (N)					BattleBots	BattleBots "You Want a Pizza Me?" End Game and HyperShock.							
E!	37	114	236	(4:30) "Never Been Kissed"	*** "Pretty Woman" (1990) Richard Gere, Julia Roberts.				*** "Pretty Woman" (1990) Richard Gere, Julia Roberts.				E! News (N)	Never Kissed			
ESPN	27	140	206	College Basketball	College Basketball Teams TBA. (Live)				College Basketball Teams TBA. (Live)			SportsCenter (N) (Live)	SportsCenter (N) (Live)				
FOOD	40	110	231	Restaurant: Impossible (N)	Beat Bobby	Beat Bobby	Beat Bobby	Beat Bobby	Beat Bobby	Beat Bobby	Beat Bobby	Beat Bobby	Beat Bobby	Beat Bobby	Beat Bobby	Beat Bobby	
FX	29	136	248	S.W.A.T.	*** "Thor" (2011, Action) Chris Hemsworth, Natalie Portman.				*** "X2" (2003, Action) Patrick Stewart. A power-mad militarist pursues the mutants.				"X-Men: The Last Stand"				
GALA	25	273	404	Una familia de diez (N)	Nosotros los guapos (N)	Vecinos (N)			40 y 20	40 y 20	Renta	Renta	Alma de	Alma de	Simón dice	Simón dice	
GOLF	24	401	218	PGA Golf	LPGA Tour Golf	HSBC Women's World Championship, Second Round. (Live)										PGA Golf	
HALL	58	185	312	"Made for Each Other" (2023) Alexandra Turshen.	Golden Girls	Golden Girls	Golden Girls	Golden Girls	Golden Girls	Golden Girls	Frasier	Frasier	Frasier	Frasier			
HGTV	41	112	229	The Flipping El Moussas	Married to Real Estate (N)	Hunters	Hunters Int'l	Married to Real Estate (N)	The Flipping El Moussas	Married to Real Estate	Hunters	Hunters Int'l					
HISTORY	44	120	269	Swamp People "Cannibal Gator" (N)	Swamp People: Serpent	(:35) Swamp People "Flying Gators"			(:03) Swamp People "Cannibal Gator"	Swamp People: Serpent	Swamp People: Serpent						
LIFE	39	108	252	Married at First Sight (N)	Married at First Sight UK (N)	(:03) Married at First Sight	Married at First Sight UK	(:01) Married at First Sight	Married at First Sight UK	(:12:04) Married at First Sight							
LIFEMOV	119	109	253	"My Diary of Lies" (2023) Noémi VanSlyke. Premiere.	"Revenge Best Served Chilled" (2022) Lynn Kim Do.	(:01) "My Diary of Lies" (2023, Drama) Noémi VanSlyke.	"Served Chilled"										
NBATV	273	156	216	NBA Special	NBA Special	NBA Special	NBA Special	NBA Special	NBA Special	NBA Special	Game of the Day						
PAR	34	241	241	** "Major League" (1989, Comedy) Tom Berenger, Charlie Sheen.				Movie	** "Major League" (1989) Tom Berenger, Charlie Sheen.								
SYFY	59	122	244	Assassin	** "Battle: Los Angeles" (2011) Aaron Eckhart, Michelle Rodriguez.				*** "Zombieland" (2009, Comedy) Woody Harrelson.	** "Leprechaun 4 in Space" (1996, Horror) Warwick Davis.							
TBS	33	139	247	Big Bang	Big Bang	Big Bang	Big Bang	Imp. Jokers	Imp. Jokers	Sheldon	Sheldon	*** "Pacific Rim" (2013) Charlie Hunnam, Diego Klattenhoff, Idris Elba.	Gemini Man				
TCM	169	132	256	*** "Breakfast at Tiffany's" (1961) Audrey Hepburn.	(:15) *** "Wuthering Heights" (1939) Merle Oberon.	(:15) **** "The Grapes of Wrath" (1940) Henry Fonda, Jane Darwell.	Around 80										
TLC	45	183	280	My 600-Lb. Life With bonus scenes. (N)	1000-Lb. Best Friends (N)	My 600-Lb. Life	My 600-Lb. Life With bonus scenes.	1000-Lb. Best Friends									
TNT	32	138	245	NBA Basketball Philadelphia 76ers at Dallas Mavericks.	NBA Basketball Los Angeles Clippers at Golden State Warriors. (Live)	Inside the NBA (N) (Live)	NBA Basketball: 76ers at Mavericks										
TRAV	49	196	277	Ghost Adventures	Ghost Adventures (N)	Ghost Adventures	Ghost Adventures	Ghost Adventures	Ghost Adventures	Ghost Adventures	Ghost Adventures	Ghost Adventures	Ghost Adventures	Ghost Adventures			
TRU TV	30	242	246	Imp. Jokers	Imp. Jokers	Imp. Jokers	Imp. Jokers	Inside Jokes	Inside Jokes	Imp. Jokers	Inside Jokes	Inside Jokes	Inside Jokes	Imp. Jokers	Imp. Jokers		
USA	31	105	242	*** "Independence Day" (1996, Science Fiction) Will Smith, Bill Pullman.	*** "The Wolverine" (2013) Hugh Jackman, Hiroyuki Sanada. Premiere.	(:45) Law & Order: Special Victims Unit											

tonight's picks



Rose McIver

6 p.m. on FOOD Restaurant: Impossible

Is it a bad sign when the most important meal of the day seems totally skippable? Powerhouse chef Robert Irvine heads to Williamston, Mich.,



"True Lies" on CBS and Paramount+ (Words in parentheses not in puzzle)

Harry	(Steve) Howey	(International) Spy
Helen	(Ginger) Gonzaga	(Language) Professor
Maria	(Erica) Hernandez	(Omega) (Sector)
Gib	(Omar) Miller	(Covert) Missions
Luther	(Mike) O'Gorman	(Top) Secret

in an attempt to resurrect the Sunnyside Café — a breakfast joint with big problems. Owner Jeanette is a world-class micromanager who refuses to make changes. Luckily, Robert wastes no time finding solutions to keep her place from closing in the new episode "Sunnyside Down."

6 p.m. on HGTV The Flipping El Moussas

Popular real estate power couple Tarek and Heather Rae El Moussa are back with this docuseries. This time around, Heather Rae is introduced to Tarek's flipping business, which is a very different world from the luxe real-estate market she knows so well. But she helps make strategic choices with her market knowledge of luxury real-estate in order to attract upscale buyers. With a host of new adventures awaiting them, this will be a nonstop whirlwind of flipping challenges and family celebrations.

7 p.m. on WE Growing Up Hip Hop

Romeo wants to apologize to Jojo and Angela, but they're hesitant to meet with him. Then Egypt continues to plan her wedding amid Sam's court case and unanswered RSVPs. And finally, Angela performs

for the first time, but her nerves might get the best of her in the new episode "Bones to Pick." Master P, Pepa, Damon Dash, and Kristinia DeBarge are also featured.

7:30 p.m. on KDBC Ghosts

As if running a bed and breakfast filled with ghosts wasn't enough to worry about, Sam (Rose McIver) has hit a wall while trying to get a biography published about Revolutionary War veteran and member of the American Continental Congress, Isaac (Brandon Scott Jones). Through her struggles she fights to keep Isaac's spirits up. Meanwhile, Trevor (Asher Grodman) and Hetty (Rebecca Wisocky) maneuver to keep their romantic relationship a secret in the new episode "Isaac's Book."

8 p.m. on KVIA2 Walker Independence

The road to revenge is often paved in the blood of innocence. And with Gus (Philemon Chambers) clinging to life, Abby (Kat McNamara), Hoyt (Matt Barr), Kate (Katie Findlay), and Calian (Justin Johnson Cortez) will stop at nothing to expose Tom's (Greg Hovanessian) corruption and bring an end to the Davidson

reign in Independence once and for all in the Season 1 finale episode "Let Him Hang." Lawrence Kao and Gabriela Quezada also star.

8 p.m. on AMC Movie: Hitman: Agent 47

This 2015 remake of a hit 2007 video game-inspired action film stars Rupert Friend ("Homeland") as a genetically engineered assassin who is endowed with strength, speed, stamina and intelligence. This formidable killer targets a mega-corporation that plans to unlock the secret of his past to create an army of killers even more powerful than he in this international co-production, which also features Zachary Quinto and Ciaran Hinds.

9:01 p.m. on KVIA Alaska Daily

Things quickly get out of hand when Concerned Citizen (Bill Dawes) targets Eileen (Hilary Swank) at gunpoint and proceeds to take her hostage in the newsroom. As the clock ticks and tension builds, Stanley (Jeff Perry), Roz (Grave Dove) and the team race to help before it's too late in the new episode "Enemy of the People." Meredith Holzman, Pablo Castelblanco, Matt Malloy and Ami Park also star.

What's Available **NOW** On **prime video**



“Movie: Brian and Charles”

From Great Britain comes this 2022 film comedy that follows the story of Brian (David Earl, “After Life”), a lonely, mostly failed inventor who builds Charles (Chris Hayward, “SOS: Save Our Skins”), an artificially intelligent robot who learns English from a dictionary and has an obsession with cabbages. Louise Brealey, James Michie and Nina Sosanya also star.



“The Head of Joaquín Murrieta”

From Mexico comes this eight-episode Western series that follows the adventures of two men — Joaquín Murrieta (Juan Manuel Bernal, “Monarca”), a legendary figure also known as the Mexican Robin Hood, and Joaquín Carrillo (Alejandro Speitzer, “Oscuro Deseo”) — who cross paths in the midst of a violent misunderstanding and join forces against a common enemy. Steve Wilcox (“Sons of Anarchy”) also stars. (ORIGINAL)



“Rules of Engagement”

This 2007-13 CBS comedy — all seven seasons of which stream here — offers three different perspectives on love and marriage, those of the token single guy (David Spade, “Just Shoot Me!”), the long-married couple (Patrick Warburton, “Seinfeld,” and Megyn Price, “Grounded for Life”) and the engaged pair (Oliver Hudson, “Nashville,” and Bianca Kajlich, “The Winchesters”).



“Daisy Jones & The Six”

Based on the novel by Taylor Jenkins Reid, this limited series tells the story of a fictional rock band that rose from obscurity to stardom in the 1970s only to suddenly call it quits following a legendary concert. Years later, they decide to reveal the truth. Riley Keough stars as Daisy, the band’s lead singer, in a cast with Sam Claflin, Will Harrison and Suki Waterhouse. (ORIGINAL)

cooking log

COOKING

Friday

8:30 p.m. FOOD Diners, Drive-Ins and Dives Chicken and waffles; biscuits and gravy and brisket chili; a house-cured meat pizza.

9:00 p.m. COOK Iron Chef America Chef Naomi Pomeroy goes up against the newest Iron Chef, Jose Garces; Naomi’s secret ingredient.

Saturday

8:30 p.m. FOOD Diners, Drive-Ins and Dives Outrageous octopus in Oregon; polenta sandwiches; biscuits and gravy; belly tacos and pig’s head.

9:00 p.m. COOK Spring Baking Championship Molly challenges bakers to be unexpected with their upside-down citrus cakes; unique takes on pies.

Sunday

8:30 p.m. COOK Man v. Food Visiting Buffalo for a nostalgic twist on the classic Buffalo wing, a chocolate delicacy and more.

9:00 p.m. FOOD Alex vs America Three chefs specializing in noodles try to knock chef Alex Guarnaschelli out of the competition.

Monday

8:30 p.m. COOK Bizarre Foods: Delicious Destinations Andrew discovers the French and German cuisine of Alsace, France.

9:00 p.m. COOK Bizarre Foods: Delicious Destinations Andrew explores the legendary and timeless cuisine of Lyon, France.

FOOD Chopped The competing chefs have to cook with ingredients representative of possible future foods.

Tuesday

9:00 p.m. COOK Anthony Bourdain: No Reservations Tony Bourdain travels to Chicago.

FOOD Chopped The chefs battle it out to see who can build the most epic burger masterpieces.

Wednesday

9:00 p.m. COOK Food Paradise Elevated grilled cheeses and sauces, a flaming hot burger, a super

sundae, a French dip and more.

FOOD Guy’s Grocery Games Guy challenges four talented chefs with budget games that might be too crazy for their own good.

Thursday

8:30 p.m. COOK Burgers, Brew & ’Que Michael Symon starts at his restaurant with a pastrami beef rib; his grandfather’s spaetzle recipe.

FOOD Beat Bobby Flay French chefs Laurent Zirotti and Eric Damidot go head to head in the arena.

9:00 p.m. COOK Burgers, Brew & ’Que Champ Burger loaded with beer-braised pork; a cookie-

brownie mashup; cola-braised brisket.

FOOD Beat Bobby Flay Restaurateurs and judges Michael Psilakis and Einat Admony compete to bring the heat.

The Truck Farm, LLC

575-523-1447
645 Alameda, Las Cruces
www.sweethots.com

For daily news updates
Subscribe to our
eBulletin

Check out the entire Bulletin in our weekly e-edition.

www.lascrucesbulletin.com

tonight's movies

A

The Adventures of Robin Hood ★★★★★ The outlaw pits his Merry Men against the evil Prince John. **TCM Wed. 6 p.m.**
The African Queen ★★★★★ A spinster and a sailor try to destroy a WWI German gunboat. **TCM Wed. 8 p.m.**
All the President's Men ★★★★★ Woodward and Bernstein uncover the Watergate scandal. **TCM Sun. 6 p.m.**
Ant-Man and The Wasp ★★★ Ant-Man and the Wasp battle a powerful new enemy. **FX Sun. 6:30 p.m.**
Apollo 13 ★★★½ Based on the true story of the ill-fated 1970 moon mission. **SYFY Tue. 5:55 p.m.**
The Avengers ★★★½ Superheroes join forces to save the world from an unexpected enemy. **FX Fri. 6 p.m.**
Avengers: Endgame ★★★½ The Avengers prepare for an

epic showdown with Thanos. **TNT Sun. 4:05 p.m.**

B

Back to the Future ★★★½ A boy travels through time to his parents' teenage years. **SYFY Fri. 7:30 p.m.**
Back to the Future Part II ★★★ Marty's time traveling is threatened by a dangerous rival. **SYFY Fri. 5 p.m.**
The Blind Side ★★★ A well-to-do white couple adopts a homeless black teen. **PAR Wed. 6 p.m.**
Breakfast at Tiffany's ★★★½ A woman hides vulnerability behind a sophisticated facade. **TCM Thu. 6 p.m.**
The Breakfast Club ★★★½ Five teenagers make strides toward mutual understanding. **AMC Sat. 4 p.m.**

C

Creed II ★★★ Boxer Adonis Johnson trains to fight Ivan Drago's son. **TNT Sat. 5:18 p.m.**

D

Despicable Me ★★★★★ Animated. Three orphans challenge one of Earth's greatest villains. **SYFY Sat. 4 p.m.**
Despicable Me 2 ★★★★★ Animated. Gru and his new partner hunt the perpetrator of a spectacular heist. **SYFY Sat. 6 p.m.**
Dirty Dancing ★★★ A sheltered teen falls for a street-wise dance instructor. **PAR Mon. 6 p.m.**

F

Father of the Bride ★★★★★ A family agonizes over a bride-to-be's immense wedding. **TCM Wed. 4:15 p.m.**
Forrest Gump ★★★★★ A slow-witted Southerner experiences 30 years of history. **PAR Tue. 6 p.m.**
Furious 7 ★★★ A dead man's brother seeks revenge on the Toretto gang. **TNT Fri. 5 p.m.**

H

The Hunger Games: Mockingjay, Part 1 ★★★★★ Katniss

fighters for Peeta and a nation moved by her courage. **AMC Fri. 6 p.m.**

I

Independence Day ★★★★★ Earthlings vs. evil aliens in 15-mile-wide ships. **SYFY Mon. 7 p.m.; USA Thu. 6 p.m.**
Iron Man ★★★ A billionaire dons an armored suit to fight criminals. **FX Sat. 8 p.m.**

K

Kingsman: The Secret Service ★★★ A dapper spy takes a troubled youth under his wing. **SYFY Mon. 4:03 p.m.**

L

Light in the Piazza ★★★ A mentally challenged woman's mother faces a hard decision. **TCM Sun. 4 p.m.**

M

The Major and the Minor ★★★½ Major eyes blonde posing as half-fare child on train.



Visit us at
www.lascrucesbulletin.com

ing as half-fare child on train.

TCM Tue. 7:45 p.m.

Continued on page 14

FRAME & ART CENTER
 1100 S. Main at Idaho in Pueblo Plaza
575-526-2808
 Mon-Fri 9-5:30 • Sat 10-3

YOUR SOURCE FOR PROFESSIONAL FRAMING
 • Custom Framing • Art Supplies • Local Art
Serving Las Cruces for over 40 Years!
WWW.FRAMEANDART.COM

crossword puzzle



The identity of the featured celebrity is found within the answers in the puzzle. In order to take the TV Challenge, unscramble the letters noted with asterisks within the puzzle.

ACROSS

1. Actor on "East New York" (2)
10. "Two and a Half Men" role
11. "___ the Chamber"; 2012 Cuba Gooding Jr. film
12. "___ Fly Away"
13. "American ___!"
14. "Sister Wives" network

16. Stolte of "Chicago Fire"
18. Prefix for night or week
20. Goulash
21. "My Three ___" (1960-72)
22. Poet Eliot's initials
23. Ad ___ committee
24. "Woe is me!"
25. Words of disgust
27. German article
28. Actor on "NCIS: Hawai'i" (2)

32. Unprocessed metal
33. Skater Babilonia
34. Comment from Annie's dog
37. Stared open-mouthed
39. Christiane __, formerly of "FBI: International"
40. Actor on "FBI" (2)

DOWN

1. Alex Tarrant's role
2. Perpendicular annex
3. ___ Kilmer
4. "___ Plain Sight" (2008-12)
5. Laugh loudly
6. "The King ___"
7. Omaha's state: abbr.
8. Eartha & others
9. "Big Trouble ___ China"; Kurt Russell film
13. Hoffman's initials
15. Sid, for one
16. PC tray inserts
17. Vane letters
18. ___ gai pan; stir-fry dish
19. "Charles ___" (1984-90)
21. Give the cold shoulder to
24. Billboards
26. Fleece sheep
29. Dating couple gossiped about
30. "My Fair ___"
31. Amanda Peet's age
34. Camera batteries, often
35. Groove
36. Role on "Alice"
38. Gym class, for short
39. "Magnum ___"

MIKES BLINDS

SALES, SERVICE

RESTRING, REPAIR, INSTALLATION

(575) 571-0417

Mike Currier nationlc2@gmail.com

www.windowtreatmentsinlascrucesnm.com

Bingo — Solution

	A	H	E	C	P
European Nations	Adonia	Andorra	Austria	England	France
Flowers	Algeria	Algeria	Algeria	Algeria	Algeria
Products	Algeria	Algeria	Algeria	Algeria	Algeria
U.S. Presidents	Algeria	Algeria	Algeria	Algeria	Algeria
Particulars	Algeria	Algeria	Algeria	Algeria	Algeria

2 for \$20 TUESDAYS

Get Two Taco Meals for \$20

4 Tacos + 1 Drink Per Person!

Los Corrales

Mexican Food

2420 W. Picacho Ave.
 575-489-6615

Crossword Solution

Tom Selleck

Solution

CELESTIAL HEARING SOLUTIONS

We are in network with most Blue Cross & Blue Shield, United Health Care and many other insurance companies. We would be happy to check your insurance for you at no obligation to see if you have any hearing benefits. Please stop by or give us a call with the information. We look forward to hearing from you.

In Arroyo Plaza • 2001 E. Lohman Ave., Ste. 112, Las Cruces

Visit us online at www.celestialhearing.com

(575)232-9022

SUDOKU

	2		1					5
	6	7	2					1
				5	9			7
		2			1			
3	1						7	4
			9			3		
6			4	9				
	4				2	1	8	
2					7		3	

To complete this puzzle, place the numbers 1-9 in the empty cells, so that every row, column and 3-by-3 box (in bold outline) contains all nine digits.

Each number 1-9 may appear only once in each row, column and 3-by-3 box.

Provided by Gracenote

9	8	4	7	1	5	8	8	2
6	8	1	2	9	3	6	2	7
2	9	7	8	6	1	4	9	8
1	9	7	3	5	4	9	6	8
8	1	6	9	8	2	6	5	7
8	6	9	1	6	3	1	7	4
1	8	3	6	5	9	2	4	7
5	6	7	2	8	4	9	1	3
9	2	4	1	7	3	8	6	5

CSL Plasma

DO THE AMAZING HELP SAVE LIVES

UP TO
\$500*

IN THE FIRST 5 DONATIONS WITHIN 30 DAYS

Donate Plasma today at
CSL PLASMA LAS CRUCES

Rocky ★★★★★ Un humilde boxeador tiene la oportunidad de cambiar su vida. **KTDO Sat. 8 p.m.**

Rocky III ★★★ A merciless contender forces Rocky into a title match. **AMC Tue. 4:30 p.m.**

T

Thor ★★★ Cast out of Asgard, the Norse god lands on Earth. **FX Thu. 6:30 p.m.**

Thor: Ragnarok ★★★ Thor must battle the mighty Hulk

and the all-powerful Hela. **TNT Mon. 5:15 p.m.**

Z

Zombieland ★★★ Survivors of an apocalypse join forces against zombies. **SYFY Sat. 8 p.m., Sun. 5 p.m.**

B I N G O

Solution is on page 13.

Fill in each box of the BINGO grid below with an answer that begins with the letter above each column and belongs to the category listed before each row. List one answer for each box, although there is more than one acceptable answer for many of the boxes.

Solution is on page 13.

	A	H	E	C	P
European Nations					
Flowers					
Insects					Free Space
U.S. Presidents					
Punctuation Marks					

Visit us at
www.lascrucesbulletin.com

INNOVATIVE PHARMACY SOLUTIONS!

Providing local, full-service pharmacy needs for all types of facilities.

- Long-term care
- Assisted Living
- DD Waiver
- Skilled Nursing
- Hospice and more

Call us today! 575-288-1412

Ask your provider if they utilize the many benefits of RX Innovations, such as: Blister or multi-dose packaging, OTC's & FREE Delivery. Learn more about what we do at www.rxinnovationslc.net

tonight's movies

Continued from page 13

The Man Who Shot Liberty Valance ★★★★★ A lawyer finds fame by supposedly gunning down an outlaw. **TCM Mon. 6 p.m.**

Mission: Impossible — Fallout ★★★½ Ethan and the IMF team must stop a terrorist nuclear attack. **FX Tue. 6 p.m.**

N

The Naked Spur ★★★ A bounty hunter has a rival for an outlaw's daughter. **TCM Fri. 6 p.m.**

National Lampoon's Christmas Vacation ★★★ A traditional Griswold yuletide backfires in comic fashion. **AMC Mon. 8 p.m.**

P

The Palm Beach Story ★★★★★ A woman leaves her husband to get money for his inventions. **TCM Tue. 6 p.m.**

Pretty Woman ★★★ A corporate raider hires a hooker to act as a business escort. **E! Thu. 7 p.m.**

R

Raiders of the Lost Ark ★★★★★ An archaeologist races Nazis to find a powerful relic. **PAR Sat. 8 p.m.**

The Rock ★★★ Alcatraz Island terrorists threaten to gas San Francisco. **FX Mon. 8 p.m.**

alternate puzzle



ACROSS

- 1. Lincoln & Reagan
- 10. Perched upon
- 11. Fred Astaire's dancing sister
- 12. Edison's monogram
- 13. Go quickly
- 14. Illuminated
- 16. Root vegetables
- 18. University in Dallas
- 20. "___ shalt not kill"
- 21. Injure
- 22. Canister
- 23. Lou Gehrig's disease, for short
- 24. Supervisor
- 25. Comedian Mort
- 27. Word attached to chair or pit
- 28. Photographer
- 32. Late Communist leader
- 33. Rotten

34. Mandible

- 37. Look of contempt
- 39. Actor Kaplan
- 40. End of December (hyph.)

DOWN

- 1. Traitor
- 2. Letter from Greece
- 3. "Annabel Lee" poet
- 4. No longer in bed
- 5. Café au ___
- 6. Creative thought
- 7. Eastwood's initials
- 8. ___ once; suddenly
- 9. Guy next door
- 13. Actress Kelly
- 15. Chinese religion
- 16. Mai tai ingredient
- 17. NBA team
- 18. Arabic greeting

- 19. Jumble
- 21. Gender: abbr.
- 24. Prohibit
- 26. Téa ___
- 29. Aid in crime
- 30. Nativity set figurine
- 31. Commercial
- 34. Jam container
- 35. Stomach muscles
- 36. Damp
- 38. Pauser's syllable
- 39. Upper ___; endoscopy





DISCOVER

THE MANY SIDES OF AAA

Stop by your local AAA New Mexico branch to take advantage of all your AAA membership has to offer, including:

<p>Insurance Competitive rates on Auto, Home and Life Insurance</p>	<p>Travel Vacation planning services, plus EXCLUSIVE AAA Member Benefits</p>	<p>MVD Save up to 90% off administrative fees versus private MVD providers</p>
--	---	---

Call: 1-877-222-1020 Visit: 3991 E. Lohman Ave.,
Click: AAA.com/TravelSale Suite A, Las Cruces, NM

Membership requires the separate payment of annual dues and an admission fee for new members. Membership is required for new insureds. AAA insurance is a collection of AAA branded products, services and programs available to qualified AAA members. AAA personal lines insurance provided by Interinsurance Exchange of the Automobile Club. Life insurance underwritten by our affiliate, AAA Life Insurance Company, Livonia, MI. AAA Life is licensed in all states, except NY. AAA New Mexico is an insurance agent for the Exchange, and acts as an agent for AAA Life. There is a \$2 administrative fee for each MVD transaction in addition to MVD fees. Fee subject to change without notice. Copyright © 2018 AAA New Mexico, LLC. All Rights Reserved.



NEW YEAR, NEW CARPET!
CARPET STARTING AT \$1.89 SQ. FT.
INSTALLED WITH PAD
MANY STYLES AND COLORS IN STOCK

Malooly's

FLOORING COMPANY since 1907

765 N. VALLEY DR. 575-523-0633

PUZZLES TOTALLY OUT OF IT

- ACROSS**
- 1 Four-string guitar
 - 5 Bits of land in el agua
 - 10 Luca Brasi in "The Godfather," e.g.
 - 16 Soft infant food
 - 19 Life -- know it
 - 20 New Mexico or Colorado county
 - 21 Useless
 - 22 Division of history
 - 23 Start of a riddle
 - 26 Mantra syllables
 - 27 Old-time cleaning cake
 - 28 Tennis' Safin
 - 29 Not skilled in at all
 - 31 Heavy weight
 - 32 All -- sudden
 - 35 Spoken
 - 37 French movie theater
 - 38 Riddle, part 2
 - 44 President Biden
 - 45 Speaks
 - 46 Singer Turner
 - 47 Tell el -- (Nile excavation site)
 - 50 It fills la mer
 - 51 Riddle, part 3
 - 57 Becomes familiar with anew
 - 59 Per-unit price
 - 60 Mortise insertion
 - 61 Ambulance VIPs
 - 62 Decorative dashboard finish
 - 66 Chain in biology
 - 67 Riddle, part 4
 - 73 China's Chou En --
- 74 Like many soda bottles, volume-wise
 - 75 Purposely ignore
 - 76 Book of charts
 - 79 IRS form IDs
 - 80 "-- is a virtue"
 - 84 Riddle, part 5
 - 87 In honor of
 - 89 Small river
 - 90 -- -mutuel betting
 - 91 Oxygen-requiring bacterium
 - 93 Start for center or Pen
 - 94 End of the riddle
 - 102 Square yardage, e.g.
 - 103 Instant replay option
 - 104 Expressive rock genre
 - 105 -- Leppard (rock band)
 - 106 Mythical man-goats
 - 109 "In the red," e.g.
 - 111 Division of history
 - 115 Concorde, e.g., in brief
 - 116 Riddle's answer
 - 120 Grassland
 - 121 Henner of "Taxi"
 - 122 -- Island (Providence's state)
 - 123 Old TV's -- May Clam-pett
 - 124 Work unit
 - 125 Workout wear
 - 126 Planted
 - 127 Some deli loaves
- DOWN**
- 1 Cry noisily
 - 2 Ghostly pale

1	2	3	4	5	6	7	8	9	10	11	12	13	14	15	16	17	18
19				20					21							22	
23			24						25							26	
27								28				29			30		
		31			32	33	34		35			36			37		
38	39			40				41				42	43				
44				45							46						
47			48	49		50			51	52	53				54	55	56
57					58			59						60			
			61			62	63				64	65			66		
67	68	69				70							71	72			
73				74							75						
76			77	78		79					80				81	82	83
84				85	86				87	88		89					
			90					91			92				93		
94	95	96					97	98	99					100	101		
102					103					104			105				
106				107	108		109			110		111	112			113	114
115				116		117				118	119						
120				121						122					123		
124				125						126					127		

PUZZLE ANSWER

S	E	R	A	D	E	M	O	S	S	V	E	M	S	G	R	E	E
A	T	T	E	E	D	O	H	R	U	I	R	V	M	V	E	T	
V	N	H	V	K	V	T	O	G	L	N	E	I	H	I	S	T	S
A	R	N	T	N	E	C	M	O	I	D	I	S	R	A	L	V	S
			F	E	M	O	M	E	O	M	O	T	S		A	R	E
R	E	D	E	N	E	T	R	A	B	A	R	E	H	T	O	M	F
I	P	E	R	A	E	R	O	B	E	A	E	R	I	A	R	I	P
M	V	A	F	T	S	T	R	E	S	T	H	E	S	V	A	M	L
E	C	E	I	E	I	P	A	T	P	A	S	S	S	S	V	L	A
			B	U	N	S	R	E	R	I	T	O	L	M	T		L
R	U	U	O	I	T	D	E	R	O	A	V	A	F	E	E	F	O
A	N	A	M	I	M	I	D	T	R	O	M	S	T	S	E	M	T
N	O	N	E	T	A	V	A	T	E	R	S	N	R	A	V	E	T
G	N	I	N	I	T	A	N	O	C	U	V	A	V	A	N	A	W
			V	N	I	T			S	R	S	T	E	T	U	E	O
L	I	A	T	K	C	O	C	O	A	D	E	T	S	E	U	O	E
E	I	N	E	C	O	A	L	O	A	V	O	F	A	N	O	T	
L	V	R	O	P	P	A	V	O	M								
S	M	S	O	R	A	V	A	B	H	T	N	I	N	E	M	I	N
A	R	A	E	S	O	I	O	T	O	T	E	R	O	E	S	W	S
P	A	P	A	N	A	V	A	N	I	T	M	A	S	I	S	L	A

SUPER CROSSWORD

- 3 Real bargain
- 4 Electric eye, e.g.
- 5 "The Tall Corn State"
- 6 Leave for a short time
- 7 Spy novelist Deighton
- 8 Exhibit works
- 9 "... or -- told"
- 10 Drag racer
- 11 New York home of Cornell
- 12 Relative of a stickpin
- 13 Raging crowd
- 14 PDQ's cousin
- 15 Emperor after Claudius I
- 16 City on the Illinois River
- 17 Ralph Lauren competitor
- 18 Pale hue
- 24 Actress Skye
- 25 Main parts of churches
- 30 Fuel rating
- 33 Galas
- 34 On the Red, e.g.
- 36 Former senator Trent
- 38 Open slightly
- 39 City in Alaska
- 40 Four-piece band
- 41 Writer Capote, to pals
- 42 Org. in many spy novels
- 43 Make a ski mask, maybe
- 48 Lagoon surrounder
- 49 Christen
- 51 Core group
- 52 Frisky swimmer
- 53 Uncool sort
- 54 About
- 55 Lower-class, to Brits
- 56 Growl threateningly
- 58 Warning initials above an internet link
- 59 Hair bases
- 62 Actress Kate of "Grey's Anatomy"
- 63 Of sheep
- 64 "Casablanca" woman
- 65 Prized buy for a coin collector
- 67 Nail on a paw
- 68 Pledge
- 69 Brand of sneakers
- 70 Didn't win
- 71 Hang it up
- 72 App that asks "Where to?"
- 77 Frolicking
- 78 Move back and forth
- 80 Open tourney, often
- 81 Necessarily
- 82 Sleeveless cloak
- 83 Arabian chief
- 85 Pooch noise
- 86 Misters
- 87 Agent's cut
- 88 "... there -- square"
- 91 Something hilarious
- 92 Fabric with raised designs
- 94 Grapple with, slangily
- 95 Slate clearer
- 96 Attachment to a dog or cat collar
- 97 "House" actress Wilde
- 98 Old-time Ford
- 99 NASA countdown term
- 100 Ferber of fiction
- 101 -- regions (Hades)
- 107 Crater edges
- 108 Novelist Irwin
- 110 Corp. VIPs
- 112 Squeezed (out)
- 113 Be in power
- 114 Jubilant cries
- 117 Exist
- 118 "So that's your trick!"
- 119 Wrecker's job

LEGAL NOTICES

*Las Cruces Bulletin - your legal publication for
Las Cruces and Doña Ana County, New Mexico*

If there is a conflict between the legal description and the street address, the legal description shall control. Unless you serve a pleading or motion in response to the Complaint in said cause on or before thirty (30) days after the last publication date, judgment by default may be entered against you. McCARTHY & HOLTHUS, LLP By: Jason Bousliman Daniel Higgins II Attorneys for Plaintiff 6501 Eagle Rock NE, Suite A-3 Albuquerque, New Mexico 87113 Telephone No.: (505) 219-4900 dhiggins@mccarthy-holthus.com IDSPub #0183806
2/10/2023 2/17/2023 2/24/2023

STATE OF NEW MEXICO COUNTY OF DONA ANA THIRD JUDICIAL DISTRICT
Cause No. D-307-PB-2023-00026
Judge: Martin, James T.
In the Matter of the Estate
JAMES DONALD MCKITTRICK, Deceased.

NOTICE TO CREDITORS
NOTICE IS HEREBY GIVEN that Charles P. Scheel and Sandra Oddenino Roberts have been appointed co-personal representatives of this estate. All persons having claims against the estate are required to present their claims within four months after the date of the first publication of this notice or the claims will be forever barred. Claims must be presented either to the undersigned personal representative at the address shown in this notice or filed within the court. The attorney for the personal representative is William L. Lutz of the law firm of

Martin & Lutz, P.C., 2110 North Main Street, Las Cruces, New Mexico, 88001. DATED this 31 day of January 2023.
/s/ Charles P. Scheel Charles P. Scheel Co-Personal Representative 3650 Morningstar Dr., Unit 170 1 Las Cruces, NM 88011
/s/ Sandra Oddenino Roberts Sandra Oddenino Roberts Co-Personal Representative 3326 Long Branch Dr., Falls Church, VA 22041
Dates: 02/10, 02/17, 02/24, 2023

STATE OF NEW MEXICO COUNTY OF DONA ANA THIRD JUDICIAL DISTRICT COURT
D-307-DM-2022-1231
Judge Grace B. Duran

Claudia Bustamante Gomez Cisneros, Petitioner Pro Se, vs. Benjamin Cisneros, Respondent.

NOTICE OF SUIT AND PROCESS OF SERVICE BY PUBLICATION

To: Benjamin Cisneros TAKE NOTICE that a lawsuit has been filed against you. The subject of this lawsuit is: divorce. If you do not file a response or responsive pleading with the above-titled Court with 30 days after the third publication of this Notice, the Court may enter a default judgement against you. Petitioner's Mailing Address: 360 Jasper, Las Cruces, NM 88001 Dated: January 24, 2023
/s/ Naomi Ramirez Naomi Ramirez Clerk of the District Court Respectfully Submitted,
/s/ Claudia Bustamante Claudia Bustamante Gomez Cisneros
Dates: 02/10, 02/17, 02/24, 2023

STATE OF NEW MEXICO IN THE PROBATE COURT DONA ANA COUNTY

No. 22-0388
In the Matter of the Estate of Juan S. Benavidez, a/k/a Johnny Benavidez, a/k/a Juan Benavidez, Deceased.

NOTICE TO CREDITORS
NOTICE IS HEREBY GIVEN that the undersigned has been appointed personal representative of the estate of the decedent. All persons having claims against the estate of the decedent are required to present their claims within four (4) months after the date of the first publication of any published notice to creditors or sixty (60) days after the date of mailing or other delivery of this notice, whichever is later, or the claims will be forever barred. Claims must be presented either to the undersigned personal representative at the address listed below, or filed with the Probate Court of Dona Ana County, New Mexico located at the following address: 845 N Motel Blvd., Las Cruces, NM 88007 Dated: January 9th, 2023.
/s/ Bernice B. Eres Bernice B. Eres 167 W. Lucero Las Cruces, NM 88005 575-642-3447 berniceberes@gmail.com
Dates: 02/10, 02/17, 02/24, 2023

NOTICE is hereby given that on January 19, 2023, Belinda and Sugilfredo Ramirez, 3440 HWY 28 Las Cruces, NM 88005 filed with the **STATE ENGINEER** Application No. LRG-05943-POD4, OSE File No. LRG-05943-AA, for Permit to Change Location of Well within the

Lower Rio Grande Underground Water Basin of the State of New Mexico by discontinuing the use of well LRG-05943-AA, located within the NW¼ SW¼ of projected Section 31, Township 23 South, Range 2 East (NMPM), and more specifically located where Latitude and Longitude intersect at 32° 15' 48.92" N, 106° 47' 8.30" W (WGS84), on land owned by the applicants, and by drilling new well LRG-05943-POD4, to a depth of 120 ft. with a 6 in. casing, to be located within the NW ¼ SW ¼ of projected Section 31, Township 23 South, Range 2 East (NMPM), and more specifically located where Latitude and Longitude intersect at 32° 15' 48.79" N, 106° 47' 8.13" W (WGS84), on land owned by the applicants, for the continued diversion of the amount of water subject to all conditions and provisions contained in the August 22, 2011 Final Judgment and Settlement Agreement in Stream System Issue No. 101, SS-97-101, combined with surface water from the Elephant Butte Irrigation District for the irrigation of 3.39 acres of land, and for the irrigation of 0.27 acres of land with groundwater only, owned by the applicant, located within the SW ¼ of projected Section 31, Township 23 South, Range 2 East (NMPM) and within the SE¼ of projected Section 36, Township 23 South, Range 1 East (NMPM) as described by Subfile No. LRN-28-013-0382, Rights A and B of the Lower Rio Grande Hydro-graphic Survey. The applicant has requested emergency

authorization to drill the proposed well under NMSA, 1978, Section 72-12-22. Old well LRG-05943-AA will be plugged. The proposed site of well LRG-05943-POD4 is located south of Las Cruces, NM and is approximately 556 ft. south of the intersection of HWY 28 and W. Union Ave. Dona Ana is the County affected by the diversion and in which the water has been or will be put to beneficial use. This notice is ordered to be published in the Las Cruces Bulletin. To view the application and supporting documentation contact the State Engineer District Office to arrange a date and time for an appointment located at 1680 Hickory Loop, Suite J, Las Cruces, NM 88005. Any person, firm or corporation or other entity having standing to file objections or protests shall do so in writing (objection must be legible, signed, and include the writer's complete name, phone number, email address, and mailing address). The objection to the approval of the application must be based on: (1) impairment; if impairment, you must specifically identify your water rights; and/or (2) Public Welfare/Conservation of Water; if public welfare or conservation of water within the state of New Mexico, you must show how you will be substantially and specifically affected. The written protest must be filed, in triplicate, with the State Engineer, 1680 Hickory Loop, Suite J, Las Cruces, NM 88005 on or before **April 7, 2023**. Facsimiles (faxes) will be accepted as a valid protest if the hard copy is hand-delivered or mailed and

postmarked within 24-hours of the facsimile. Mailing postmark will be used to validate the 24-hour period. Protests can be faxed to the Office of the State Engineer, at 575-524-6160. If no valid protest or objection is filed, the State Engineer will evaluate the application in accordance with the provisions of Chapter 72 NMSA, 1978.
Dates: 02/10, 02/17, 02/24

STATE OF NEW MEXICO IN THE PROBATE COURT DONA ANA COUNTY

No. D-307-PB-2021-00220
In the Matter of the Estate of Nicholas F. Porter, Deceased.

NOTICE TO CREDITORS

NOTICE IS HEREBY GIVEN that the undersigned has been appointed personal representative of the estate of the decedent. All persons having claims against the estate of the decedent are required to present their claims within four (4) months after the date of the first publication of any published notice to creditors or sixty (60) days after the date of mailing or other delivery of this notice, whichever is later, or the claims will be forever barred. Claims must be presented either to the undersigned personal representative at the address listed below, or filed with the Probate Court of Dona Ana County, New Mexico, located at the following address: general delivery 201 E. Las Cruces Ave., Las Cruces, NM 88001. Dated: February 8, 2023.

/s/ Michael A. McAdams Michael A. McAdams 321 W Mountain Ave. Apt 4,

Las Cruces, NM 88005
716-410-5976
Michaelamcads73@gmail.com
Dates: 02/17, 02/24, 03/03, 2023

STATE OF NEW MEXICO COUNTY OF DONA ANA THIRD JUDICIAL DISTRICT COURT

Case No. D-307-DM-2022-787
Judge Jessica L. Streeter
Cinthia N Saenz Lopez, Petitioner V.

Richard Labrado Jr., Respondent.

NOTICE OF SUIT

To Richard Labrado Jr., Respondent: Take notice that a lawsuit has been filed against you. The subject of this lawsuit is: divorce w/ children. If you do not file a response or responsive pleading with the above-titled Court within 30 days after the third publication of this Notice, the court may enter a default judgment against you. Petitioner's Name: Cinthia N. Saenz Lopez 105 Comerciantes Blvd. Santa Teresa, NM 88008 575-888-1054
WITNESS the Honorable Jessica L. Streeter, District Judge of the Third Judicial District Court of the State of New Mexico and the seal of the District Court of Dona Ana County, this 6th day of December 2022.
David Borunda Clerk of the District Court
Dates: 02/17, 02/24, 03/03, 2023

STATE OF NEW MEXICO COUNTY OF DONA ANA THIRD JUDICIAL DISTRICT COURT

No. D-307-PB-2023-00045
Judge James T. Martin

In the Matter of the Eli H. Mabry, Deceased.

NOTICE TO CREDITORS

NOTICE IS HEREBY GIVEN that CHARLES EDWARD MABRY has been appointed Personal Representative of this estate. All persons having claims against said

CREDITORS
NOTICE IS HEREBY GIVEN that the undersigned has been appointed the Personal Representative of this estate. All persons having claims against this estate are required to present their claims within four months after the date of the first publication of this Notice or the claims will be forever barred. Claims must be presented either to the undersigned Personal Representative in care of Joseph M. Holmes, P.A., PO Box 366, Las Cruces, New Mexico 88004-0366, or filed with the Third Judicial District Court, 201 W. Picacho, Las Cruces, New Mexico 88005.
Dated: February 3, 2023

/s/ Eva Rel Eva Rel, Personal Representative of the Estate of Elvira Alvarez, Deceased Prepared & Submitted by: Joseph M. Holmes, P.A. PO Box 366 Las Cruces, NM 88004-0366 575-524-0833 holmespa@zianet.com
/s/ Joseph M. Holmes Joseph M. Holmes Attorney for the Estate

Dates: 02/17, 02/24, 03/03, 2023

STATE OF NEW MEXICO COUNTY OF DONA ANA THIRD JUDICIAL DISTRICT COURT

No. D-307-PB-2023-00045
Judge James T. Martin

In the Matter of the Eli H. Mabry, Deceased.

NOTICE TO CREDITORS

NOTICE IS HEREBY GIVEN that CHARLES EDWARD MABRY has been appointed Personal Representative of this estate. All persons having claims against said

LEGAL NOTICES

*Las Cruces Bulletin - your legal publication for
Las Cruces and Doña Ana County, New Mexico*

estate are required to present their claims within four (4) months after the date of the first publication of this Notice or the claims will be forever barred. Claims must be presented either to the undersigned counsel for Personal Representative or filed with the Clerk of the Third Judicial District Court, 201 W. Picacho, Las Cruces, New Mexico 88005. Melissa J. Reeves, P.C., /s/ Melissa J. Reeves-Evins
Melissa J. Reeves-Evins
NM State Bar No. 7629
200 W. Las Cruces Ave., Ste. A Las Cruces, NM 88005
575-522-5009 522-5031 FAX Attorney for Personal Representative
Dates: 02/17, 02/24, 03/03, 2023

NOTICE is hereby given that on January 19, 2023, Daniel J. Shaw and Georgia Mowad, 111 Calle Delphia Anthony, NM, 88021 filed with the **STATE ENGINEER** Application No. LRG-00524-POD9, OSE File No. LRG-00524-O, for Permit to Change Location of Well, Place and Purpose of Use within the Lower Rio Grande Underground Water Basin of the State of New Mexico by transferring 1.0 acre-foot per annum of water, historically used for commercial dairy purposes at the former River Valley Dairy located within Section 28, Township 25 South, Range 3 East (NMPM), from well LRG-00524, located within the NW ¼ NE ¼ of Section 28, Township 25 South, Range 3 East (NMPM), and more specifically located where Latitude and Longitude intersect at 32° 6' 37.18" N,

106° 38' 18.19" W (WGS84), and well LRG-00524-S, located within the NW ¼ NE ¼ of Section 28, Township 25 South, Range 3 East (NMPM), and more specifically located where Latitude and Longitude intersect at 32° 6' 37.14" N, 106° 38' 17.52" W (WGS84), both on land owned by Robert Abercrombie. Said 1.0 acre-foot per annum is to instead be divided for commercial greenhouse use located within the NW¼ SW¼ of projected Section 16, T 27 South, Range 3 East (NMPM), by drilling new well LRG-00524-POD9, to be located within the NW¼ SW¼ of projected Section 16, Township 27 South, Range 3 East (NMPM), and more specifically located where Latitude and Longitude intersect at 31° 57' 31.69" N, 106° 38' 54.73" W (WGS84), on land owned by the applicants. Wells LRG-00524 and LRG-00524-S will be retained for other rights. The proposed site of move-to well LRG-00524-POD9 is east of La Union, NM and is approximately 670 ft. north of the intersection of HWY 28 and Calle Delphia. Dona Ana is the County affected by the diversion and in which the water has been or will be put to beneficial use. This notice is ordered to be published in the Las Cruces Bulletin. To view the application and supporting documentation contact the State Engineer District Office to arrange a date and time for an appointment located at 1680 Hickory Loop, Suite J, Las Cruces, NM 88005. Any person, firm or corporation or other entity having standing to file

objections or protests shall do so in writing (objection must be legible, signed, and include the writer's complete name, phone number, email address, and mailing address). The objection to the approval of the application must be based on: (1) Impairment; if impairment, you must specifically identify your water rights; and/or (2) Public Welfare/Conservation of Water; if public welfare or conservation of water within the state of New Mexico, you must show how you will be substantially and specifically affected. The written protest must be filed, in triplicate, with the State Engineer, 1680 Hickory Loop, Suite J, Las Cruces, NM 88005 on or before **April 14, 2023**. Facsimiles (faxes) will be accepted as a valid protest if the hard copy is hand-delivered or mailed and postmarked within 24-hours of the facsimile. Mailing postmark will be used to validate the 24-hour period. Protests can be faxed to the Office of the State Engineer, at 575-524-6160. If no valid protest or objection is filed, the State Engineer will evaluate the application in accordance with the provisions of Chapter 72 NMSA 1978.

Dates: 02/17, 02/24, 03/03, 2023

STATE OF NEW MEXICO COUNTY OF DOÑA ANA THIRD JUDICIAL DISTRICT

D-307-
CV-2022-02033
Judge Fitch

Cecilia Garcia and Henry Garcia, Petitioners/Plaintiffs,
v.
Leilani Novak, also known as Leilani Novak-Garcia, Respondent/Defendant.

SERVICE BY PUBLICATION
TO: LEILANI NOVAK, a/k/a LEILANI NOVAK-GARCIA
You are required to serve upon Joshua Dwyer, Attorney for Petitioners Cecilia Garcia and Henry Garcia, an answer or motion in response to the "Petition for Declaratory Judgment, Complaint for Conversion, Fraud, and Unjust Enrichment, and Petition to Determine and Quiet Title to Real Property" filed against you in the above-referenced case within thirty (30) days after publication of this notice and file your answer or motion with the court as provided in Rule 1-005 NMRA. If you fail to appear or file a timely answer or motion, default judgment may be entered against you for the relief demanded in the complaint/petition. Attorney for Petitioners: Joshua Dwyer/ScottHulse, P.C. 201 N. Church St., Ste. 201 Las Cruces, NM 88001
Telephone: (575) 522-0765
jdwy@scotthulse.com
Dates: 02/24, 03/03, 03/10, 2023

STATE OF NEW MEXICO COUNTY OF DOÑA ANA THIRD JUDICIAL DISTRICT COURT

No. CV-2023-181
In the Matter of the Petition of
Mary Elizabeth Cuellar

For Change of Name
NOTICE OF PETITION TO CHANGE NAME
NOTICE IS HEREBY GIVEN that Mary Elizabeth Cuellar, a resident of the City of Las Cruces, County of Dona Ana, State of New Mexico, and over the age of fourteen years, has filed a Petition to Change Name in the

Third District Court, Dona Ana County, New Mexico, wherein she seeks to change her name from Mary Elizabeth Cuellar to Mary Elizabeth Gandara, and that this Petition will be heard before the Honorable Casey B. Fitch, District Judge, on the 20th day of March, 2023, at the hour of 1:30 p.m., at the Dona Ana County Courthouse, 201 W. Picacho, Las Cruces, New Mexico. Respectfully submitted,
/s/ Mary Cuellar
Mary Cuellar
2076 Reina Dr.
Las Cruces, NM 88007
575-956-8229
Dates: 02/24, 03/3, 2023

IN THE STATE OF NEW MEXICO COUNTY OF DOÑA ANA THIRD JUDICIAL DISTRICT COURT

No. D-307-
PB-2023-00046 Hon. Manuel I. Arrieta
In the Matter of the Estate of Chrystal Bates, Deceased.

NOTICE TO CREDITORS
NOTICE IS HEREBY GIVEN that the undersigned has been appointed personal representative of this estate. All persons having claims against this estate are required to present their claims within four (4) months after the date of the first publication of this notice, or the claims will be forever barred. Claims must be presented either to the undersigned personal representative at the address listed below, or filed with the District Court of Dona Ana, County, New Mexico, located at the following address: 201 West Picacho Avenue, Las Cruces, NM 88005. Dated: Feb. 16, 2023.
/s/Jeffrey Bennett
Jeffrey Bennett

322 S. Geronimo Rd. Apache Junction, AZ 85119
Submitted: E-Law, PC.
/s/ Michele Ungvarsky
Michele Ungvarsky, Esq.
Bar No. 8100
1340 Picacho Hills Drive
Las Cruces, NM 88007
575-556-2462
Attorneys for the Estate of Chrystal Bates, deceased.
Dates: 02/24, 03/03, 03/10, 2023

STATE OF NEW MEXICO COUNTY OF DOÑA ANA THIRD JUDICIAL DISTRICT

PB-2023-0020
JUDGE MARTIN
In the Matter of the Estate of Cipriano Fierro, Deceased.

NOTICE TO CREDITORS
NOTICE IS HEREBY GIVEN that the undersigned have been appointed Co-Personal Representatives of this estate. All persons having claims against this estate are required to present their claims within four months after the date of the first publication of this Notice, or the claims will be forever barred. Claims must be presented wither to the undersigned Co-Personal Representatives, in care of the Bates Law Firm, PO Box 305, Las Cruces, NM 88004-0305, or filed with the Third Judicial District Court, 201 W. Picacho Avenue, Suite A, Las Cruces, NM 88005

Dated: 01/19/2023
/s/ Melissa A Jackson,
Melissa A Jackson
Co-Personal Representative of the Estate of Cipriano Fierro, Deceased
/s/ Sonya F. Fierro
Sonya F. Fierro
Co-Personal Representative of the Estate of Cipriano

Fierro, Deceased
Prepared and submitted by:
Bates Law Firm
PO Box 305
Las Cruces, NM 88004-0305
575-524-8585
575-524-1895 Fax
/s/ Lloyd O. Bates Jr.
Lloyd O. Bates Jr.
Attorney for the Estate
NM Bar No. 175
Dates: 02/24, 03/03, 03/10, 2023

STATE OF NEW MEXICO COUNTY OF DOÑA ANA THIRD JUDICIAL DISTRICT

Cause No. D-307-
PB-2023-00029
Judge: Arrieta, Manuel I.

In the Matter of the Estate BARBRA LYNN HAYES, Deceased.

NOTICE TO CREDITORS
NOTICE IS HEREBY GIVEN that Michelle Karnes has been appointed personal representative of this estate. All persons having claims against the estate are required to present their claims within four months after the date of the first publication of this notice or the claims will be forever barred. Claims must be presented either to the undersigned personal representative at the address shown in this notice or filed within the court.

The attorney for the personal representative is William L. Lutz of the law firm of Martin & Lutz, P.C., 2110 North Main Street, Las Cruces, New Mexico, 88001. Dated this 10th day of February 2023
/s/ Michelle Karnes
Michelle Karnes
Personal Representative
324 S. Florence Ave., Apt #B
Sandpoint, ID 83864
Dates: 02/24, 03/03, 03/10, 2023

88001. Dated this 10th day of February 2023
/s/ Michelle Karnes
Michelle Karnes
Personal Representative
324 S. Florence Ave., Apt #B
Sandpoint, ID 83864
Dates: 02/24, 03/03, 03/10, 2023

STATE OF NEW MEXICO COUNTY OF DOÑA ANA THIRD JUDICIAL DISTRICT COURT
No. CV-2022-2203
In the Matter of the Petition of Cassandra Jean Hoisington For Change of Name
NOTICE OF PETITION TO CHANGE NAME
NOTICE IS HEREBY GIVEN that Cassandra Jean Hoisington, a resident of the

THE STATE OF NEW MEXICO DOÑA ANA COUNTY THIRD JUDICIAL DISTRICT COURT
D-307-
PB-2022-00046
Judge James T. Martin
In the Matter of the Estate of Thomas G. Collins, Deceased
NOTICE OF HEARING

Petitioner, CHARLES KIRK AMES, through his attorney, ScottHulse, P.C. (Joshua Dwyer), gives the following notice to any persons who may have an interest in this matter: The hearing on the Petition for Formal Probate of Will and Formal Appointment of Personal Representative will be held at 9:00 a.m., March 29, 2023, Third Judicial District Court, Courtroom 7, 201 W. Picacho Avenue, Las Cruces, New Mexico 88005. The hearing is scheduled to occur via telephone/video conference. Contact the Court or counsel for more information. Respectfully:
/s/ Joshua Dwyer
Joshua Dwyer
Attorney for Petitioner
ScottHulse PC
201 North Church Street, Suite 201
Las Cruces, New Mexico 88001
575-522-0765
575-522-0006 facsimile email: jdwy@scotthulse.com
Dates: 02/24, 03/03, 03/10, 2023

STATE OF NEW MEXICO COUNTY OF DOÑA ANA THIRD JUDICIAL DISTRICT COURT

No. CV-2022-2203
In the Matter of the Petition of Cassandra Jean Hoisington For Change of Name
NOTICE OF PETITION TO CHANGE NAME
NOTICE IS HEREBY GIVEN that Cassandra Jean Hoisington, a resident of the

LEGAL NOTICES

*Las Cruces Bulletin - your legal publication for
Las Cruces and Doña Ana County, New Mexico*

City of Las Cruces, County of Dona Ana, State of New Mexico, and over the age of fourteen years, has filed a Petition to Change Name in the Third Judicial District Court, Dona Ana County, New Mexico, wherein she seeks to change her name from Cassandra Jean Hoisington to Cassandra Jean Rucks, and that this Petition will be heard before the Honorable Casey B. Fitch, District Judge, on the 20th day of March 2023, at the hour of 1:30 p.m. at the Dona Ana County Courthouse, Las Cruces, the Dona Ana County Courthouse, Las Cruces, New Mexico. Respectfully submitted,
/s/Cassandra J Hoisington
Cassandra J Hoisington
1868 El Presidio
Las Cruces, NM 88011
360-269-2695
Dates: 02/24, 03/03, 2023

STATE OF NEW MEXICO COUNTY OF DONA ANA THIRD JUDICIAL DISTRICT

Case No.: D-307-CV-2022-01036
BOKF, NA, Plaintiff,
vs.
JOE HENRY CASTILLO, JR.,
Defendant.

NOTICE OF FORECLOSURE SALE
PLEASE TAKE NOTICE that the above-entitled Court, having appointed me or my designee as Special Master in this matter with the power to sell, has ordered me to sell the real property (the "Property") situated in Dona Ana County, New Mexico, commonly known as 1208 Chaparro St, Las Cruces, NM 88001, and more particularly described as follows: LOT 21, 22 AND 23, BLOCK 11,

(AMENDED PLAT) VALLEY VIEW ADDITION, IN THE CITY OF LAS CRUCES, DONA ANA COUNTY, NEW MEXICO, AS THE SAME IS SHOWN AND DESIGNATED ON THE PLAT NO. 46, THEREOF FILED FOR RECORD IN THE OFFICE OF THE COUNTY CLERK OF SAID COUNTY ON APRIL 24, 1907, AND RECORDED IN BOOK 3, FOLIO 44, PLAT RECORDS. Including any mobile home, and any and all improvements, fixtures, and attachments. If there is a conflict between the legal description and the street address, the legal description shall control. The sale is to begin at 10:00 AM on April 25, 2023, outside the main entrance of the 3rd Judicial District Courthouse, 201 W. Picacho, City of Las Cruces, County of Dona Ana, State of New Mexico, at which time I will sell to the highest and best bidder for cash, in lawful currency of the United States of America, the Property to pay expenses of sale, and to satisfy the foreclosure Judgment granted on February 13, 2023, in the total amount of \$90,204.31, with interest at the rate of 3.5000% per annum from September 6, 2022 through the date of the sale. The sale is subject to the entry of an Order by this Court approving the sale. NOTICE IS FURTHER GIVEN that the real property and improvements concerned with herein will be sold subject to any and all patent reservations, easements, and all taxes and utility liens, special assessments and taxes that may be due. BOKF, NA, its attorneys,

and the undersigned Special Master, disclaim all responsibility for, and the purchaser at the sale takes the property "as is," in its present condition, subject to the valuation of the property by the County Assessor as real or personal property, affixture of any mobile or manufactured home to the land, deactivation of title to a mobile or manufactured home on the property, if any, environmental contamination on the property, if any, and zoning violations concerning the property, if any. **NOTICE IS FURTHER GIVEN** that the purchaser at such sale shall take title to the above described real property subject to a one (1) month right of redemption. **PROSPECTIVE PURCHASERS AT SALE ARE ADVISED TO MAKE THEIR OWN EXAMINATION OF THE TITLE AND THE CONDITION OF THE PROPERTY AND TO CONSULT THEIR OWN ATTORNEY BEFORE BIDDING.** By: Margaret Lake 201 Eubank NE Suite #A1 Albuquerque, NM 87123 1 NM-22-900246-JUD IDSPub #0184141
Dates: 2/24, 3/3, 3/10, 3/17, 2023

STATE OF NEW MEXICO COUNTY OF DONA ANA THIRD JUDICIAL DISTRICT COURT
No. CV-2022-2395
Manuel I. Arrieta
In the Matter of the Petition of Isaac Moreno
For Change of Name
NOTICE OF PETITION TO CHANGE NAME
NOTICE IS HEREBY GIVEN that Isaac Moreno, a resident of the City of Las Cruces, County of Dona Ana, State

of New Mexico, and over the age of fourteen years, has filed a Petition to Change Name in the Third Judicial District Court, Dona Ana County, New Mexico, wherein he seeks to change his name from Isaac Moreno to Isaac Moreno-Carrillo, and that this Petition will be heard before the Honorable Manuel I. Arrieta, District Judge, on the 12th day of April 2023, at the hour of 11:00 a.m., at the Dona Ana County Courthouse, 201 W. Picacho Ave., Las Cruces, New Mexico. Respectfully submitted,
/s/ Isaac Moreno
Isaac Moreno
7517 Sierra De Luna Place,
Las Cruces, NM 88012
575-556-4874
Dates: 02/24, 03/03, 2023

NOTICE is hereby given that on January 18, 2023, Manuel C. Bustamante and Brenda C. Bustamante, P.O. Box 404, Salem, New Mexico 87941, filed with the **STATE ENGINEER** Application No. LRG-13196-POD2, OSE File No. LRG-13196-1, for Permit for an Additional Point of Diversion within the Lower Rio Grande Underground Water Basin of the State of New Mexico by supplementing existing well LRG-13196-POD1, located within NE $\frac{1}{4}$ SE $\frac{1}{4}$ of Section 26, Township 18 South, Range 4 West (NMPM), and more specifically located where Latitude and Longitude intersect at 32° 42' 44.475" N and 107° 12' 56.48" W (WGS84), on land owned by the applicant; with an additional well LRG-13196-POD2 to be located within NE $\frac{1}{4}$ SE $\frac{1}{4}$ of Section 26, Township 18 South, Range 4 West (NMPM), and more specifically located where Latitude and Longitude intersect at 32° 42' 44.703" N and 107° 12' 56.494" W (WGS84), on land owned by the applicant, for the continued diversion of the 3.0 acre-feet per annum, for single-household domestic use on land owned by the applicant, located within the NE $\frac{1}{4}$ SE $\frac{1}{4}$ of Section 26, Township 18 South, Range 4 West (NMPM), as described by Subfile Order No. LRR-28-005-0104 Right B of the Third Judicial District Court, County of Dona Ana, State of New Mexico. The proposed supplemental well LRG-13196-POD2 will be located approximately 740 feet north of the intersection of Father Ramon Estivill Avenue and Hoover Street. Dona Ana is the County affected by the diversion and in which the water has been or will be put to beneficial use. This notice is ordered to be published in the Las Cruces Bulletin. To view the application and supporting documentation contact the State Engineer District Office to arrange a date and time for an appointment located at 1680 Hickory Loop, Suite J, Las Cruces, NM 88005. Any person, firm or corporation or other entity having standing to file objections or protests shall do so in writing (objection must be legible, signed, and include the writer's complete name, phone number, email address, and mailing address). The objection to the approval of the application must be based on: (1) Impairment; if impairment, you must specifically identify your water rights; and/or (2) Public Welfare/Con-

servaion of Water; if public welfare or conservation of water within the state of New Mexico, you must show how you will be substantially and specifically affected. The written protest must be filed, in triplicate, with the State Engineer, 1680 Hickory Loop, Suite J, Las Cruces, NM 88005 on or before **April 7, 2023**. Facsimiles (faxes) will be accepted as a valid protest if the hard copy is hand-delivered or mailed and postmarked within 24-hours of the facsimile. Mailing postmark will be used to validate the 24-hour period. Protests can be faxed to the Office of the State Engineer, at 575-524-6160. If no valid protest or objection is filed, the State Engineer will evaluate the application in accordance with the provisions of Chapter 72 NMSA 1978.

Dates: 02/24, 03/03, 03/10, 2023

STATE OF NEW MEXICO COUNTY OF DONA ANA THIRD JUDICIAL DISTRICT

No. D-307-CV-2022-00687
ROCKET MORTGAGE, LLC F/K/A QUICKEN LOANS, LLC F/K/A QUICKEN LOANS INC.,
Plaintiff,
vs.
THE ESTATE OF SARAH BURKHALTER, Deceased;
MICHAEL QUINCEY BURKHALTER, individually and as Personal Representative of the Estate of Sarah Burkhalter, Deceased; LAS CRUCES MEDICAL CENTER, LLC; and THE UNKNOWN HEIRS, DEVISEES OR LEGATEES OF SARAH BURKHALTER, Deceased,
Defendants.
NOTICE OF SALE
NOTICE IS HERE-

BY GIVEN that on March 22, 2023, at the hour of 10:00 a.m., the undersigned Special Master will, at the main entrance of the Dona Ana County Judicial Complex, 201 W. Picacho, Las Cruces, New Mexico, sell all the right, title and interest of the above-named Defendants in and to the herein-after described real estate to the highest bidder for cash. The property to be sold is located at 5017 Troybrook Road, Las Cruces, and is situate in Dona Ana County, New Mexico, and is particularly described as follows: LOT NUMBERED 43 IN BLOCK LETTERED J OF RINCON MESA SUBDIVISION, PHASE 2, LAS CRUCES, DONA ANA COUNTY, NEW MEXICO, AS THE SAME IS SHOWN AND DESIGNATED ON THE PLAT OF SAID RINCON MESA SUBDIVISION, PHASE 2, FILED IN THE OFFICE OF THE COUNTY CLERK OF DONA ANA COUNTY, NEW MEXICO ON MARCH 23, 2007 IN PLAT BOOK 22, FOLIO 164-165. RATIFICATION OF PLAT FILED APRIL 18, 2007 IN BOOK 806 PAGES 1267 AS DOCUMENT NO. 13698 OF DONA ANA COUNTY RECORDS. THE FOREGOING SALE will be made to satisfy a judgment rendered by the above Court in the above entitled and numbered cause on February 13, 2023, being an action to foreclose a mortgage on the above described property. The Plaintiff's Judgment, which includes interest and costs, is \$150,581.10 and the same bears interest at 4.250% per annum from October 2, 2022, to the date of sale.

The Plaintiff and/or its assignees has the right to bid at such sale and submit its bid verbally or in writing. The Plaintiff may apply all or any part of its judgment to the purchase price in lieu of cash. The sale may be postponed and rescheduled at the discretion of the Special Master. **NOTICE IS FURTHER GIVEN** that the real property and improvements concerned with herein will be sold subject to any and all patent reservations, easements, all recorded and unrecorded liens not foreclosed herein, and all recorded and unrecorded special assessments and taxes that may be due. Plaintiff and its attorneys disclaim all responsibility for, and the purchaser at the sale takes the property subject to, the valuation of the property by the County Assessor as real or personal property, affixture of any mobile or manufactured home to the land, deactivation of title to a mobile or manufactured home on the property, if any, environmental contamination on the property, if any, and zoning violations concerning the property, if any. **NOTICE IS FURTHER GIVEN** that the purchaser at such sale shall take title to the above described real property subject to a one month right of redemption. Electronically filed /s/ Pamela A. Carmody
Pamela A. Carmody,
Special Master
PO Drawer 16169
Las Cruces, NM 88004-6169
(575) 642-5567
Dates: 02/24, 03/03, 03/10, 03/17, 2023

Looking back: Las Cruces' Nestor Armijo family

By MIKE COOK
Las Cruces Bulletin

Tuesday, Feb. 28, 2023, is the 192nd birthday of Don Nestor Armijo, patriarch of one of the most important families in Las Cruces history.

The property he bought (for \$4,050) in 1877 at 150 E. Lohman Ave., now called the Armijo House, is today home to the Greater Las Cruces Chamber of Commerce (GLCCC). A 2015 historic preservation grant from the New Mex-

ico Historic Preservation Division and the National Park Service Historic Preservation Fund helped Mesilla Valley Preservation, Inc. (MVP) renovate the house, and the chamber held a grand opening Dec. 7, 2017.

Research conducted by MVP, in partnership with Architectural Resources Group based in San Francisco, shows the likely builder of the two-story adobe house, in 1866, was Mesilla Valley pioneer John D. Barncastle, MVP said in a news release. The carpenter likely responsible for the house's defining woodwork was Benjamin Franklin Hanover, MVP said.

Barncastle and Hanover

were veterans of the Union Army who came to the Mesilla Valley with the California Column that marched nearly 1,000 miles through Arizona and New Mexico territories April through August 1862, during the second year of the American Civil War.

Nestor Armijo was born Feb. 28, 1831, in Los Padillas, New Mexico, now part of Albuquerque. He was the eldest son of Juan Cristobal Armijo and Juana Chavez, according to historical records.

Armijo attended St. Louis University and married Maria Josefa Yrissari (1838-1906) in 1851. In 1853, Armijo drove 55,000 sheep from New Mexico to Cali-

fornia, braving multiple manmade and natural dangers along the way. Armijo and his younger brother, Nicolas, ran mule trains transporting goods from St. Louis to stores Nestor Armijo owned in Las Cruces (opened in 1862), El Paso and Chihuahua, Mexico.

Armijo was credited with thousands of acts of charity and in February 1904, was elected first vice

president of the new Mesilla Valley Chamber of Commerce – the president was Hiram Hadley (1833-

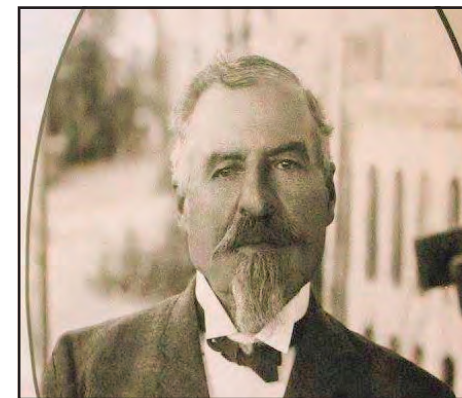

Nestor Armijo in a photo that is part of a display at the Greater Las Cruces Chamber of Commerce, which now resides in the Armijo family home, originally built in 1866.



BULLETIN PHOTOS BY MIKE COOK

The Armijo family plot in San Jose Cemetery on Espina Street.

SEE **ARMIJO**, PAGE 23



COURTESY PHOTO

'Matilda' closes this weekend. With a cast of 25 led by Mia Berkson in the starring role, Las Cruces Community Theatre (LCCT) presents the last three performances of "Matilda, the Musical" at 7:30 p.m. Friday-Saturday, Feb. 24-25, and 2 p.m. Sunday, Feb. 26, at LCCT, 313 N. Main St. Tickets are \$17 for adults, \$14 for seniors, students and military and \$10 for children. Call LCCT at 575-523-1200. Visit www.lcctnm.org.



COURTESY PHOTO

The play "Hookman" continues its opening weekend with performances are 7:30 p.m. Friday, Feb. 24, Saturday, Feb. 25, at the ASNMSU Center for the Arts, 1000 E. University Ave. It is produced by the New Mexico State University Theatre Department and has been called "part dark comedy, part slasher horror and part truthful moving story." Tickets are \$20 general admission, \$18 for students, \$16 for seniors and military and \$10 for children under age 18. You can purchase tickets online at theatre.nmsu.edu, via phone at 575-646-4515, or at the ASNMSU box office before each performance.

Diven delivers editorial cartoonist confessions in arts talk

BULLETIN REPORT

The Doña Ana Arts Council (DAAC) continues its inaugural month at its new location, 230 S. Water St. downtown, and the ongoing celebration of For the Love of Arts Month, with a talk by beloved Las Cruces artist and polymath Bob Diven.

Diven's "Confessions of an Editorial Cartoonist" will give a "behind-the-pen glimpse" into how and why an editorial cartoon comes into being, DAAC said in a news release. The talk will be 4-5 p.m. Saturday, Feb. 25, at DAAC.

Tickets are \$10 or two for \$15 and are avail-

able at DAAC, by phone (575-523-6403) and at the door.

Diven – actor, playwright, theatrical designer, musician, composer, photographer, filmmaker, painter, sculptor, rat catcher and dragon builder – has been drawing editorial cartoons for the Sunday edition of the Las Cruces Sun-News for 15 years. His commentary on the major events, political upheavals, minor scandals and the weather of our community and region has won several awards, as has his book, "Living in Las Cruces," the new release said.

Diven describes his cartoons as "less like an axe and more like a flashlight, shining light on issues that deserve attention," DAAC said.

Diven's goal with "Confessions of an Editorial Cartoonist" is to "give out more information than anyone really wanted to know about what goes into my editorial cartoons!"

For more information, contact DAAC's new executive director, Araceli Solis, at 575-523-6403 and director@daarts.org. Visit daarts.org/.



Blood drive for cancer

BULLETIN REPORT

The Game II Sports Bar and Grill, 4131 Northrise Drive, will host a Warrior Blood Drive and Pediatric Cancer Awareness event 9 a.m.-3 p.m. Saturday, Feb. 25, Game II owner Marci Dickerson said.

The community is invited to attend and donate blood during the event. Donors will receive a free appetizer coupon and a \$10 Amazon gift card. The event will include a craft table for kids and speakers sharing their warrior journeys between noon and 1 p.m.



KIND BREAD COMPANY

NATURALLY LEAVENED BREAD & PASTRIES

201 SOLANO DR. STE G
LAS CRUCES
575-993-1560

KIND BREAD CO.
2019
Naturally Leavened

Tues-Fri: 7am-6pm | Sat: 7am-2pm
WALK-INS WELCOME

BECOME A MENTOR TODAY



NATIONAL MENTORING MONTH

BIG BROTHERS BIG SISTERS MOUNTAIN REGION IS LOOKING FOR VOLUNTEERS LIKE YOU TO MAKE A BIG IMPACT IN A CHILD'S LIFE.

REQUIREMENTS

- 1 year commitment, 4-6 hours per month
- Must be 18 years old and pass background check
- Training and staff assistance will be provided

PROGRAM TYPES

- Community Based
- School-Based
- *High School Students as Bigs (age 15-18)

Call 575-449-2728 to sign up today or go to www.bbbsmountainregion.org



Cigar Aficionado SPECIAL EVENT! March 25th



Food Truck! Live Music! Raffles!

Starts @ 4pm

Live Music @ 6pm

The VYBES Band featuring Stinger J. and Kiki

CIGAR AFICIONADO EVENT - CIGAR AFICIONADO GUEST SPEAKER WILL BE HECTOR BECERRA WITH QUESADA CIGAR

Enter to Win Box of Cigars and other Prizes!

\$35/per guest!

VIP ACCESS Limited Seating!
Purchase Tickets @ Casa De Tobacco
2460 S Locust St Ste F, Las Cruces
(575) 571-4199



TRUST PROPERTIES
RentinLC.com
forrentinlascruces.com • (575) 312-1593

Angela Potter / Qualifying Broker
Lic# 18483.
Eviction Services, Property Management,
Investment Consultants and more.

Proud Sponsor of
El Paso Comic Con
Apr. 21-23, 2023



MOONBOW
ALTERATIONS • SEWING • BOOKS

New Hours **Tuesday, Thursday & Friday ~ 1 to 6pm**
Saturday ~ 10am to 2pm
Closed ~ Sunday, Monday & Wednesday

Moonbow's Book Nook • Books by Local Authors

225 E. Idaho #32
Las Cruces
(By Oriental Palace)

Alice B. Davenport
(575) 527-1411

MVFG announces March artists

BULLETIN REPORT

Mesilla Valley Fine Arts Galley (MVFG), 2470-A Calle de Guadalupe on the historic plaza in Mesilla, will feature the art of Woody Hoffman and Jane Madrid during the month of March.

Hoffman retired from the Colorado Department of Agriculture and moved to Las Cruces in 2004, where he took up the hobby of woodturning, MVFG said in a news

release. Hoffman regularly attends symposiums to hone his skills, learn new techniques and improve and update his equipment. He belongs to Artists of Picacho Hills, and his work has shown in galleries in Las Cruces and Santa Fe. Most of the wood he uses is from recycled sources, previously destined for firewood, but special woods and burls are purchased for special pieces. All utilitarian pieces have a food-safe finish, MVFG said.

Madrid has been a Las Cruces resident since 1959 and has painted since age 8. Her serious work began around 2005, the news release said. Madrid's main



A bowl by Woody Hoffman

media is oil and some acrylic. Her major artistic themes center around nature, with a particular emphasis on animals, flowers, birds and landscapes. Madrid is an active member in several organizations and promotes art in the area.

First American Bank, 1553 Avenida de Mesilla, features the work of many of the gallery's artists.

MVFG is open 10 a.m.-5 p.m. every day.

Call 575-522-2933. Visit www.mesillavalley-finearts.com.



Jane Madrid's roadrunner.

MONAS offerings for March

BULLETIN REPORT

The Las Cruces Museum of Nature and Science (MONAS) will offer free programs for children and families in March. Admission to the museum and programs are free. No registration is required.

- "Nature & Science Discovery Pre-K," 10 a.m. Thursdays, 2, 9, 16, 23 and 30. Nurture your little one's love of science as you investigate alien life through hands-on explorations, stories and crafts. Recommended for ages 2-5 with an adult caregiver.
- "Teen Takeover: T-shirt Tie Dye," 6-8 p.m. Wednesday, March 8. Teens play with the

exhibits, make and experiment with STEAM (science, technology, engineering, arts and mathematics) activities, eat snacks and play games during extended hours just for ages 12-17. Teens can tie dye a one-of-a-kind tee shirt. One tee shirt will be provided. Bring up to two additional clothing items to dye.

- "Saturday Science – Balloon Powered Cars," 10 a.m.-noon, Saturday, March 11. Design, build and test a balloon-powered car. Recommended for ages 6 and up with an adult caregiver.
- "Live Animal Feedings," 11 a.m. Saturdays, March 4 and 11. Watch and learn how different species of animals eat and what

they eat. Feedings take place in the MONAS gallery. For all ages.

• "Animal Encounters," 11 a.m.-noon Saturday, March 25. Get up close and personal with the invertebrates of the Nature Center at the Las Cruces Museum of Nature & Science. Learn about the Chihuahuan Desert's biodiversity and meet some of the museum's resident animals. For all ages.

For information contact Stephanie Hawkins at 575-532-3372 and shawkins@lascruces.gov.

Visit www.lascruces.gov/museums and follow Las Cruces Museums on Facebook, Instagram and Twitter @LCMuseums.

Henn to exhibit Bosque series

BULLETIN REPORT

Artist Matt Henn will have an exhibition of his works 4-7 p.m. Saturday, March 4, at "Hair and Body." 2222 Avenida de Mesilla. The show, entitled "Bosque del Apache: February Hues," will include 21 painting from Henn's second series dedicated to national wildlife refuge near San Antonio, New Mexico. The paintings "were done completely with palette

knives," Henn said. All of them are oil on stretched canvas.

The paintings "all have gray skies," Henn said. "This is intentional, as it is my representation of the days Lee (his wife) and I visited (the bosque) in February 2019. It was cold and drizzly and always overcast. I did my best to convey this and hope the viewer gets this feel. I had to create many of the skies so that each

painting projects a different day. It was fun challenge."

Henn, 76, didn't start painting until he was 40. After a long career as a construction worker, roofer, handyman and writer, he found his life's passion with a brush or a palette knife in his hand.

"I just fell into it," said Henn, a native New Yorker who moved to Las Cruces from near San Antonio, Texas, with his

wife, Lee, in 2015.

They left Las Cruces for Fredericksburg, Texas, in 2019, and Henn has been trying to schedule a return exhibition since then – cancelled three times previously because of the pandemic.



COURTESY PHOTO

Matt Henn's "Psalm" is part of his series on the Bosque del Apache, which will show March 4 at Hair and Body in Mesilla.

Gallery 925 has art reception

BULLETIN REPORT

Gallery 925 in Las Cruces' Mesquite Historic District will carry its For the Love of Art Month "Painting and Photography Show" through an artists' reception 1-8 p.m. Friday, March 3, at the gallery, 925 N. Mesquite St., just south of the intersection of Mesquite and Spruce Street.

The show features art and photography by Diane Alire (gallery owner and artist), Diana Ayres, Nancy Frost Begin, Emmitt Booher, Savannah and Vikki Cordova, Kyle Cunningham, Linda Gendall, Shaunna Foster, Matt Henn, Candice Hogan, Cassandra Lockwood, Bonnie Allen Rice, Jim Rodgers, Noel Sandino, Storm Sermay, David Sorensen, David Stevenson, Mel Stone, Gabriele Teich, Leslie Toombs, Victor Whitmill, Jean Wilkey, Nolan Winkler and Gail Ann Wodzin.

The First Friday features free trolley rides with stops at participating Mesquite Street galleries, 5-8 p.m.

The show will close Sunday, March 5.

Gallery hours are 1-5 p.m. Friday and 11 a.m.-5 p.m. Saturday and Sunday. Contact Alire at 505-417-8028 and artserf@fastmail.com.

Visit gallery925nm.com and follow the gallery on Facebook at Gallery925L-



COWBOY DAYS RETURN TO FARM & RANCH MUSEUM

BULLETIN REPORT

Culture, skill and entertainment will be in abundance at the New Mexico Farm and Ranch Heritage Museum's (NMFRHM) 23rd annual Cowboy Days celebration, 9 a.m.-4 p.m. Saturday, March 4, at the museum, 4100 Dripping Springs Road.

Admission is \$10 per carload, the museum said in a news release.

This year marks the return of the Castro family performance group of Lienzo Charro El Pedregal in Vado, New Mexico, NMFRHM said. Daniel Castro and several family members will perform trick roping and traditional charreada demonstrations 11:30 a.m.-12:15 p.m. and 2:30-3:15 p.m. on Saturday.

"Charreada is a festive event that features a variety of equestrian activities as well as costumes and music that bring a uniquely Latino culture to a sport that has its roots in Spain," the news release said.

"The best part of what we do is that we're able to do it as a family," Castro said. "My kids are by my side learning part of our culture and tradition through our shows. It's impor-

tant to us to keep our heritage alive for future generations."

Seating is limited for the charreada performances in the round pen.

The Parade of Breeds cattle program is a staple of Cowboy Days. NMFRHM Livestock Manager Greg Ball brings six breeds of beef cattle into the round pen to discuss their history and characteristics 10:30-11:30 a.m. and 1:30-2:30 p.m.

Linda McDaniel of Alamo gordo will be at Cowboy Days with her working dogs, who will demonstrate herding at 10 a.m., noon and 3:30 p.m.

Pony rides for children, priced at \$5, will be 9-11 a.m. and 1-3 p.m., with limited tickets available.

Horseshoeing demonstrations will be held 10-10:30 a.m. and 1-1:30 p.m., and chuckwagon cooking, blacksmithing and fiber arts demonstrations will take place throughout the day. The local chapter of Back Country Horsemen will do horse care demonstrations such as saddling and grooming, at 10:45 a.m., 11:45 a.m., 12:45 p.m., 1:45 p.m., 2:45 p.m. and 3:45 p.m.

Cowboy Days guests can enjoy the music of Las Cruces' Neal McCowan 12:30-3:30 p.m., have lunch at participating food trucks and shop at craft booths and the museum plant sale.

Ollie Reed of the Western Writers of America will do a presentation in the museum the-

ater at 2 p.m. A New Mexico journalist since 1976, Reed received the 2016 Rounders Award, which is presented by the New Mexico Department of Agriculture to those who "live, promote and articulate the western way of life."

Reed also will do a presentation at the museum at 2 p.m. Friday, March 3. This special "school day" of Cowboy Days is for several hundred area school children touring the museum and visiting about 20 educational activity stations, NMFRHM said.

Presenters on March 3 will include are musicians and storytellers Crow and Karla of Las Cruces, Fort Selden State Historic Site, New Mexico State University Cooperative Extension Service master gardeners, Back Country Horsemen, Mesilla Valley Cowbells, High Noon Leather, City of Las Cruces Museums, Thomas Branigan Memorial Library, New Mexico Department of Game and Fish, Asombro Institute, Doppler Dave Speelman from KVIA-TV in El Paso, New Mexico Ag in the Classroom and fiber arts demonstrations by NMFRHM volunteers.

A highlight on Friday, March 3 is the Sheep to Shawl program, with sheep shearing most of the day, beginning at 10 a.m.

The public is invited to enjoy the educational activity stations, the sheep shearing plant sale, and see the museum's exhibits and livestock on March 3. Regular admission applies: \$5 for adults, \$4 for senior citizens and \$3 for children ages 4-17.

Cowboy Days schedule (Saturday, March 4)

9 a.m. to 4 p.m.: Continuous activities: Wool carding, spin-



COURTESY PHOTOS

Cowboy Days at the New Mexico Farm & Ranch Heritage Museum takes place Saturday, March 4. Pony rides are just one of the activities available.

ning and weaving demonstrations, chuckwagon cooking, blacksmith demonstrations, craft booths, food trucks, plant sale, exhibits.

9-11 a.m.: Pony rides for children near the pony barn. (\$5). Limited number of tickets.

10-10:30 a.m.: Horseshoeing demonstration on the South 20.

10-10:30 a.m.: Working dog demonstration near the sheep barn.

10:30-11:30 a.m.: Parade of Breeds cattle program in the round pen.

10:45 a.m.: Back Country Horsemen's horse care demonstration near the bridge.

11:30 a.m. to 12:15 p.m.: Charreada and trick roping performance in the round pen.

11:45 a.m.: Back Country Horsemen's horse care demonstration near the bridge.

12-12:30 p.m.: Working dog demonstration near the sheep barn.

12:30-3:30 p.m.: Neal McCowan music in the courtyard.

12:45 p.m.: Back Country

Horsemen's horse care demonstration near the bridge.

1-3 p.m.: Pony rides for children near the pony barn (\$5). Limited number of tickets.

1-1:30 p.m.: Horseshoeing demonstration on the South 20.

1:30-2:30 p.m.: Parade of Breeds cattle program in the round pen.

1:45 p.m.: Back Country Horsemen's horse care demonstration near the bridge.

2 p.m.: Ollie Reed and the Western Writers of America in the theater.

2:30-3:15 p.m.: Charreada and trick roping performance in the round pen.

2:45 p.m.: Back Country Horsemen's horse care demonstration near the bridge.

3:30-4 p.m.: Working dog demonstration near the sheep barn.

3:45 p.m.: Back Country Horsemen's horse care demonstration near the Bridge.

Call NMFRHM at 575-541-4100. Visit www.nmfarmandranchmuseum.org.



The Castro Family performance group will be part of the Charreada and trick roping program.

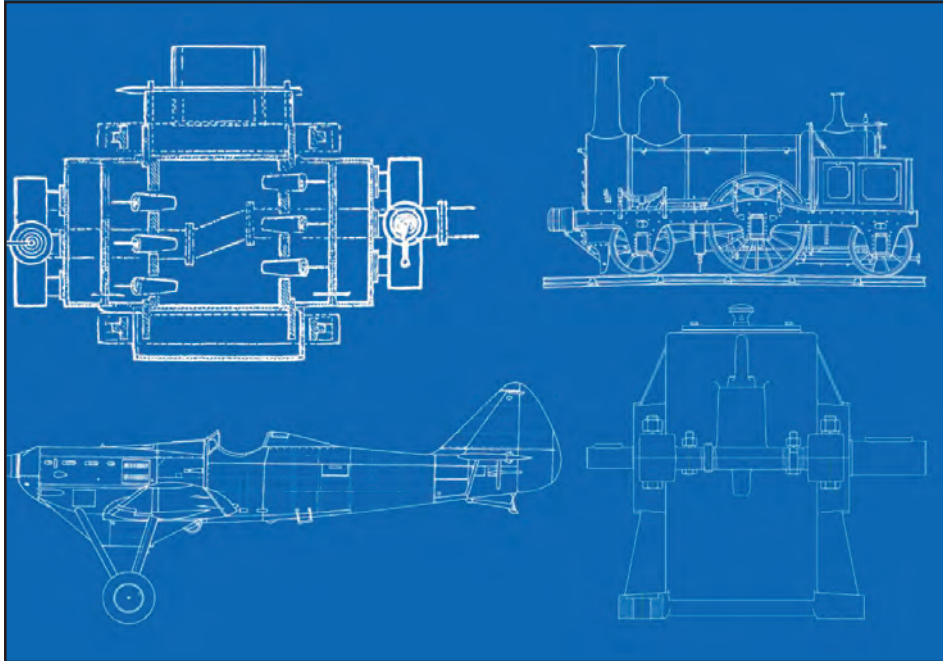

COURTESY PHOTO

Civil, Mechanical, Electrical, Oh My! What does an engineer really do? Visit the Las Cruces Railroad Museum 10 a.m.-2 p.m. Saturday, Feb. 25, to find out. Engineers from NASA, Atomic Aggies, City of Las Cruces, NMSU's chapter of American Institute of Aeronautics and Astronautics will answer questions at the Engineering Expo at the museum, 351 N. Mesilla St. For more information contact Tori Pyle at 575-528-3444 and vpyle@lascruces.gov. Visit www.lascruces.gov/museums and follow Las Cruces Museums on Facebook and Instagram @LCMuseums.



Multi-media artist Gina Gwen Palacios draws upon her family history and Mexican American identity to create portraits of her family's lived experiences in the south Texas/Mexico borderland.

Branigan Cultural Center
January 14 - March 25, 2023

 Branigan Cultural Center
501 North Main Street, Las Cruces, NM 88001
575-541-2154 • www.lascruces.gov/museums
@LCMuseums



Submitted by South Central
Solid Waste Authority

Growth in Recycling Means Growth for the SCSWA Team



The Recycling Center, 2855 W. Amador Avenue, is looking for employees to help grow the Las Cruces recycling program.

The growth of recycling in Las Cruces, and for the world, is part and parcel to a sustainable future. The South Central Solid Waste Authority (SCSWA) sees an opportunity in the growth, particularly for the workforce that will need to grow along with the industry. Two new SCSWA positions being filled are for Recycle Department Laborer, the first line for customer service for the Recycling Center at 2855 W. Amador Avenue.

"These positions are brand new to help aid customers who come in person and want to recycle but aren't 100 percent sure what goes where," said SCSWA Program Administrator Miguel Fernandez. "These positions may be for those early in their

recycling career. We are investing in developing our workforce and will get these employees certified on the forklift and certified under the Environmental Protection Agency's Clear Air Act to extract freon or coolant from refrigeration units before recycling metals."

The full-time workers will complete the recycling department's residential and commercial work orders, including delivering, repairing, or removing containers.

"Other duties include the coverage of our recycle and bulk waste operation areas which will require the use of hand tools, sprayers, yard equipment, and light equipment operation," said SCSWA Recycling

Operations Foreman Daniel Ortega. "Regular attendance is an essential function of this job because we have residents and commercial businesses coming at various times of the day, depending on their needs."

The position will also inspect vehicle loads and monitor incoming loads for unacceptable materials. The best candidate will have one year of full-time experience performing laborer or related duties, with a preference for a high school diploma and bilingual (English/Spanish) ability. A valid driver's license and an acceptable driving record are required. For more information about the jobs and for how to apply, please go to: <https://www.scswa.net/Jobs>

South Central Solid Waste Authority manages recyclables and solid waste for residents and businesses throughout Doña Ana County. Contact SCSWA at (575) 528-3800 or visit www.SCSWA.net.

ARMIJO

CONTINUED FROM 18

1922), founder of New Mexico College of Agriculture and Mechanic Arts, which became New Mexico State University.

Nestor and Josefa's son, Carlos (1855-1903), married Beatriz Otero in 1877. Carlos Armijo

managed Three Rivers Ranch ("Tres Ritos") near Tularosa, which his father owned. Carlos and Beatriz, who both pre-deceased Nestor and Josefa, had four children who survived to adulthood: Nestor Jr., Dolores, Gertrudis ("Nina") and Josepha ("Josephine"). Three of the four married siblings of the prominent

Ascarate family of Las Cruces; Josephine married Peter Gallagher of El Paso.

Nestor Armijo lived in the house that bears his name until his death there on May 7, 1911, at age 80. Members of the Armijo family are buried in their own section of San Jose Cemetery, 101 N. Espina St.

The chamber has many original photographs of Armijo and his family and a sizeable collection of family heirlooms.

New Mexico State University Archives and Special Collections has "quite a lot of Armijo family papers, photographs, etc.," said Department Head Dennis Daily.



COURTESY PHOTO

A historic photo of the Armijo House at 150 E. Amador Ave.

Worship Services



Presbyterian



FIRST
PRESBYTERIAN
CHURCH

Sunday
Morning
Worship
10:30 AM

www.fpc.lc

200 E. Boutz Road
575-526-5559

New Thought

Wellspring
140 W. Taylor Rd. | Las Cruces, NM
a new thought spiritual community

Sunday Service: 11AM

Sunday's message
Rev. Bram Watkins

Discussion Group
9:30AM

See website for more details
wellspringnow.com

Christian

First
Church of
Christ, Scientist

Sunday:
Service & Sunday School
10 a.m.

Wednesday:
Testimonies 7 p.m.

All are WELCOME!

325 West Mountain Ave.
Las Cruces, NM
575-523-5063

Christian



momentum
CHURCH

SUNDAY

Nursery and Childrens program offered for all ages.

9:00am

10:30am

12:00pm

Servicio En Español

Location:
1630 Hickory Loop
Las Cruces, NM 88005
(Across Drury Hotel)
575-805-9515



www.momentumlas Cruces.com

Advertise your worship
services today!
Call 524-8061

Christian

unity
of Las Cruces

welcomes and
encourages all who are
seeking spiritual growth
through positive, practical
Christianity.

Sunday Service: 9am
Wed. Meditation and
Healing Service: 6pm

Sr.Min: Rev. Helen Wright
Asst Min:
Rev. Jennifer Kleitz

575 N Main St.
Las Cruces, NM 88001
575-640-5323
unityoflas Cruces.org



Lutheran

Peace
Lutheran
Church

Sunday Worship
9:00 a.m.

We are Reconciling in Christ
- We welcome LGBTQA+
and ALL who seek to know
God and grow in Faith.

1701 E. Missouri Ave.
Las Cruces, NM
575-522-7119

www.peacelutheranlc.com

Episcopal

ST. ANDREW'S
EPISCOPAL
CHURCH

"Digging deep
wells so others
may drink."



Rector:
The Rev. Jonathan Hanneman

SUNDAY SERVICES:

8:30 AM - Rite I Eucharist
(In-person)

10:30 AM - Rite II Eucharist
(In-person and via Facebook Live)

WEEKDAY SERVICES:

Tuesday, 9:30 AM -
Morning Prayer (In-person)

Thursday, Noon - Eucharist
and Healing Service (In-person)

518 N. Alameda Blvd.
526-6333
www.SaintAndrewsLC.org

Lutheran

TRINITY LUTHERAN
CHURCH-ELCA

Pastor Catherine Lemons

Worship with us
in person 10 am
every Sunday
and on Zoom
through our website
www.trinitylutheranlc.org

2900 Elks Drive
575.523.4232



Methodist

university
united methodist church

Rev. Dr. Heike Miller

Sunday Worship

Traditional Services:
8:30am & 11:00am

Journey Praise Services:
9:45am

*childcare during
9:45 and 11:00 am services*

Online Services:
YouTube & website

2000 South Locust Street
575.522.8220
www.uumc-lc.org
office@uumc-lc.org

Jewish

TEMPLE BETH-EL
OF LAS CRUCES

"A diverse, welcoming and
growing Jewish community
committed to learning,
social justice and acts of
loving kindness."

Shabbat prayer and study:
Kabbalat Shabbat Friday night
at 6:00 PM

Shabbat Shachrit Saturday
morning at 10:30 AM

Rabbi Evette Lutman:
"Come grow with us!"

Member of the Union
of Reform Judaism

WWW.TBELC.ORG
3980 Sonoma Springs Ave
575-524-3380



Methodist

St. Paul's
United Methodist Church

Sunday Services
8:30 and 10:30

Child Care Provided

255 W Griggs
www.stpaulslascruces.com



Pointing people to the grace
of God found in Jesus through:

- inspirational worship
- radical inclusion
- alleviation of suffering

Sunday Mornings
*9:15 AM - Worship w/ Band
10:15 AM - Storytelling + Sunday School
11:15 AM - Worship w/ Choir
*in person + online at www.mstarlc.church

2941 Morning Star Drive, 88011
www.mstarlc.church | 575.521.3770

Call 524-8061 to be included

Rawson celebrates 50 years

In February 1973, Leonard Lee Rawson, a third generation licensed contractor, founded Las Cruces Door, now known as Rawson Builders Supply.

He began manufacturing door units locally for his builder friends, slowly adding more building supplies and services through the years.

Today Rawson Builders Supply provides a full line of materials including doors, windows, fireplaces, shower doors, hardware, lighting as well as commercial hollow metal and

storefronts. Many of our current customers are the children of those early builder associates. We are now celebrating 50 years of doing business in Las Cruces as well as across southern New Mexico and El Paso.

Along with Lee, family members Moira, Benjamin, Kirsten, and Philip are actively engaged in all aspects of the business along with several grandchildren.

In recent years, Benjamin has grown Rawson Building Supply outside of Las Cruces to better serve the Southwest.

He has led the acquisition of Artistic Entryways in Sunland Park and Jack White Fireplaces in El Paso.

Philip is a fourth generation licensed contractor. The grandchildren represent the fifth generation of Rawsons serving the construction industry in our community.

With Lee and Benjamin's vision and leadership along with a current team that includes Brian Saunders, Manuel Galindo, Dawn Sutton, Alree Sweat, Ruben Duran, and Jim Williams, Rawson Builders Supply has be-

come a leading provider to residential and commercial contractors as well as to home owners in our community.

Rawson Builders recently issued a news release with the following message:

"Our business has been enriched by many talented employees, some of whom have served with us for over 40 years. We are grateful for our many loyal customers who have trusted us with their building needs through five decades. We look forward to serving our community many more generations!"

Training available for small businesses

BULLETIN REPORT

Staff members with the City of Las Cruces' Community Development and Economic Development departments will host open forum, or "walk-in" sessions 3-4:30 p.m. every Wednesday in the Community Development Department, room 700 at City Hall, 700 N. Main St., the city said in a news release.

The first open forum will be held Wednesday, March 1. Information will be provided on zoning regulations, building tenant improvements, application processing for permits and business registrations, along with project development assistance and general discussion on business plans, the city said.

"This small business forum intent is to help those who have business development questions about how to start in getting their doors open for business operations," said Community Development Director Larry Nichols. "The Economic Development Department team, led by Director Elizabeth Teeters, will bring their enthusiasm in contributing their expertise to the forum."

Law offices of Kenneth G. Egan

MOTORCYCLE ACCIDENTS

21 Years Experience
Trial Work

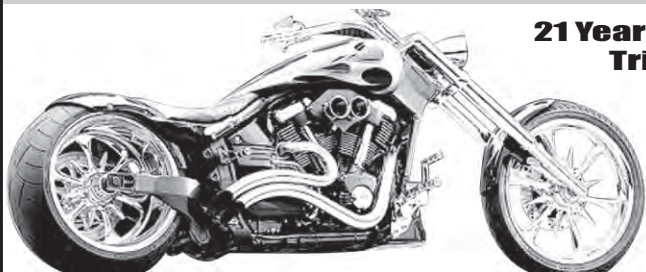

Free Consultation

575-523-2222

1111 E. Lohman
(Next to Pep Boys)

Visit us at
www.eganlawoffices.com

LCS-1V/4/5/09

Streeter, Dugan open law firm

BULLETIN REPORT

Former Third Judicial District Judge Jessica Streeter has resigned from her position as Las Cruces municipal judge and has announced the opening of a new Las Cruces law firm, Adelante Legal Services, LLC.

The opening of the law firm marks Streeter's return to private practice after her time as a district court judge and municipal court judge, Streeter said in a news release.

Streeter will be joined in the new law firm by Michael Dugan, a family law lawyer with more than 25 years of experience, Streeter said.

"The firm will focus

on family law, with an emphasis on mediation and unbundled legal services to help families resolve their family law issues without the need for contested hearings," the news release said.

"While acting as a judge, I saw that many of the cases could have been handled without waiting for a court hearing if the parties had known about other options," Streeter said.

"Our firm hopes to help people address their legal issues thoroughly and professionally while ensuring people know all



STREETER

of their options including alternatives to court."

The law firm is located at 333 S. Campo St.

Streeter was appointed district court judge in Las Cruces by Gov. Michelle Lujan Grisham in February 2022.

Streeter presided almost exclusively over family law cases during her time on the bench, she said.

After her term expired last Dec. 31, she was appointed municipal judge 2 beginning Jan. 1, 2023.

Streeter's previous law firm won Bulletin's Best Estate Planning Attorneys in 2021 and was the runner-up for Best Law Firm that same year.

For more information, call 575-541-1721. Visit adelante.law.

Who speaks for you? What do they say?

Get your guide to the 2023 NM Legislative Session

The Las Cruces Bulletin's annual Southwest New Mexico Legislative Guide is available now. The guide features profiles of state senators and representatives in our region, and gives their expectations of this year's legislative session.

You'll find information about the nine counties in our southwest region and rosters for all 70 representatives and 42 senators. There are many new faces and names this year. Our award-winning publication is a great way to get to know who they are.



Reserve your copy for free home delivery in the Las Cruces area by contacting Becky Jimenez at circulation@lascrucesbulletin.com. Or call 575-524-8061. You can also come by our offices at 1740-A Calle de Mercado to pick one up. If you're not in our home delivery area, mail copies are available for \$4.

AN ALL-ACCESS PASS TO THE COMMUNITY NEWS YOU LOVE

Visit lascrucesbulletin.com today to see what's going on in the greater Las Cruces area in southern New Mexico



THE LAS CRUCES
Bulletin

CLAY
TODAY

THE
RECORDER
Serving Ponte Vedra, St. Augustine, The Beaches and Greater St. Johns County

VISIT OUR FAMILY OF AWARD-WINNING PUBLICATIONS

LasCrucesBulletin.com | ClayTodayOnline.com | PonteVedraRecorder.com

Rejuvenation



COURTESY PHOTO

Memorial Medical Center (MMC) on Feb. 7 thanked the New Mexico State University School of Nursing for the donation of an energy pod for the hospital's new rejuvenation room. MMC also credited Sigma Theta Tau Pi Omega Chapter for transporting the pod. This technology and private room allows MMC's team members a chance to refresh their minds and bodies as they serve the community, MMC said in press release.

FYI+, LC3, Apple merge on mental health app

BULLETIN REPORT

To help fill a local behavioral health need, Families & Youth Innovations Plus (FYI+) Training & Technical Assistance Division hosted a brainstorming session for stakeholders in January in Las Cruces to create a mobile app.

Representing 12 agencies, 35 participants were divided into seven groups for the competition, FYI+ said.

They included mental health providers, people with lived experience,

faith leaders and members of the business community.

The challenge was "to create an app that could be used by everyone who is in need of behavioral health services, in collaboration with Apple, Inc., local community partners and the LC3 Behavioral Health Collaborative, the strategic hub for behavioral health in Doña Ana County," FYI+ said.

The winning design was named "Doña Ana Assistance," FYI+ said.

The group that designed it was comprised of "promotoras" (community health care workers) who primarily spoke Spanish, public health and mental health providers and a person with lived experience, FYI+ said. The slogan for their app was "No crisis too big or too small."

The app idea is designed for all ages, is multilingual and would respond "to anyone who is in a mental health

SEE MOBILE, PAGE 27

NEW MEXICO FARM & RANCH HERITAGE MUSEUM

- Pony rides for kids (\$5)
- Parade of Breeds cattle program
- Working dogs • Cowboy music
- Chuckwagon cooking
- Horseshoeing
- Western Writers of America
- Demonstrations
- Craft and food vendors



By Andersen©16"

\$10 a vehicle



March 4

Saturday, 9am to 4pm

Daniel Castro and family of Lienzo Charro El Pedregal perform trick roping and traditional Mexican charreada demonstrations!

575-522-4100

4100 Dripping Springs Road

www.nmfarmandranchmuseum.org

MOBILE

CONTINUED FROM 26

crisis by offering different options,” including speaking with or texting a therapist or counselor.

It would also offer different coping skills to immediately assist a person in crisis, such as breathing techniques, mindful meditation and de-escalation techniques, FYI+ said, along with navigation to local mental and behavioral health resources. And, it would allow the user to connect to the 988 crisis hotline and the Doña Ana

County Crisis Triage Center.

With the app design workshop completed, the next step is three more workshops facilitated by Apple which will take the concepts of the larger group and fine tune them and come out with a finalized app design based on the data and input gathered from the meeting we hosted,” said FYI+ community organizer Logan Howard.

NMSU’s Arrowhead Center might take the lead in the app’s actual development, said Howard, “based on the final product coming out of the Apple sessions.”

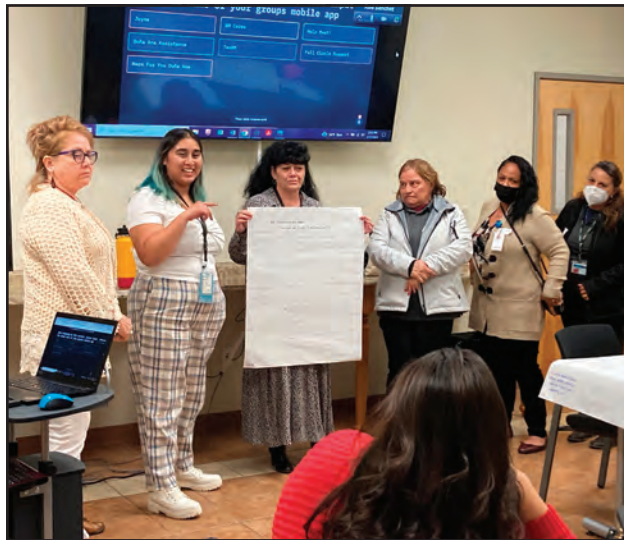

COURTESY PHOTO

Participants from 12 different agencies to conceive a design for a mobile app to assist with mental health. The challenge was to create a concept that could be used by everyone.

10-year Guarantee

MERAZ PAINTING INC.

ELASTOMERIC STUCCO COATING

ELASTOMERIC ROOF COATING

SPECIAL STAIN & EPOXY CONCRETE COATING

LC3-LV44136

575.649.8193 • 575.382.5824

www.merazpainting.com

Call for FREE Estimates

5% off when you mention this ad!



Las Cruces Utilities (LCU) has several programs in place to make sure the Las Cruces community is safe. One such program is a continuous leak survey for regulator high pressure gas maintenance.

Every morning by 6 A.M. LCU Leak Surveyors are scanning the streets in trucks equipped with special leak detection technology. Six cones hanging six inches from the ground use a vacuum pump to detect a natural gas leak within an 80-foot radius. If the truck surveillance equipment detects a leak, the Leak Surveyors confirm it with an additional handheld device.

In total, there are three LCU Leak Surveyors running road checks and answering last minute emergency calls.

LEAK SURVEYOR: Regulator high pressure gas maintenance.

By C.T. Barnes

The City of Las Cruces is split into four quadrants that are swept continuously on a five-year schedule to ensure all areas are surveyed for safety.

“We drive three miles per hour (MPH) when conducting these sweeps,” LCU Natural Gas Leak Surveyor Javier Holguin pointed out. “It can get dangerous when the community does not understand what we are doing and fly past us even when we have our lights flashing,” Holguin continued.

Once a natural gas leak is identified, it is reported and rated. These ratings are based on location to the public, severity of the leak based on size, and when they were called in. The highest-level rating is a Grade 1 natural gas leaks that

are in busy, high traffic areas or if the natural gas is migrating towards a home or business, these leaks receive immediate attention. A Grade 2 natural gas rating is given to leaks in more rural areas and are repaired within six months. A Grade 3 Natural Gas Leak is the lowest rating is given to gas leaks that are low level and in areas with little to no traffic. These are fixed within 15 months. No matter the level, all leaks are monitored regularly for the safety of the community.

After a gas leak is identified, rated, and repaired, the cleaning process starts. The soil around the gas leak holds some of the natural gas that was escaping. This will cause the area to read as if there is still a natural



LCU leak survey truck
- Courtesy LCU

gas leak although it has already been repaired and is harmless. A special machine is brought in to clean the ground around a leak.

“It is important for our citizens to know that they need to call our Utilities Dispatch at 575-526-0500 immediately if they smell gas,” LCU Natural Gas Leak Surveyor Mario Pacheco pointed out. “Most of the time when we respond to a call it is a false alarm, but the times that it is a true gas leak we are able to fix it quickly and secure the area,” Pacheco concluded.

Other LCU safety programs include corrosion surveys of natural gas lines, continuous recertification courses, and annual drills with LCU and the local fire department.

CLEANWATER service provided to more than 38,000 customers.

“The best part of my job is operating heavy equipment, and providing safe, clean water to our customers.”

Your Utility Connection

<https://www.las-cruces.org/2001/Work-For-Us> Customer Central: (575) 541-2111

SAFEGAS CLEANWATER DEPENDABLE WASTEWATER RELIABLE SOLID WASTE

ROBERT MERAZ
Heavy Equipment Operator

LCU – Your Utility Connection. Customer Central can be reached at 575-541-2111 from 8 a.m. - 6 p.m. Monday through Friday. LCU provides clean, safe, and reliable services to Las Cruces residents and businesses. Learn more at: las-cruces.org/180/Utilities For emergencies, call Dispatch at 526-0500.

PGA merchandise show back in business in a big way

In January I attended my 23rd annual PGA Show in Orlando.

The 70th edition of golf's largest industry gathering witnessed a long-awaited infusion of positive energy with no pandemic restrictions. More than 30,000 PGA professionals, golf leaders, industry executives and golf merchandise companies from 86 countries came together at the Orange County Convention Center. The PGA Show, which began with golf pros selling merchandise out of the trunks of their cars at a winter tournament in Florida in 1954, has since developed into golf's longest-running and largest global business, industry, trade display and convention. More than 800 media members (including me) reported from the event.

The week started out on a glorious warm and sunny Tuesday with Demo and Fitting Day at Orange County National Golf

Center in nearby Winter Garden, where industry attendees had a chance to try out golf clubs and other equipment in exhibitors' tents and hitting bays positioned along the 2/3 mile circumference and 700 yard diameter circular practice range. It's a treat.

Stepping onto the exhibition floor at the Convention Center the next morning you might think you were at an auto show instead of a golf show, with the proliferation of high-end, tricked-out golf cars on display everywhere.

They aren't your father's golf carts anymore; they're golf cars.

Another thing one notices among the 800 exhibitors is the continued emergence of golf simulators. A golf simulator is a large fabric screen (12x15 feet large), where a golfer hits balls off a mat at a screen displaying realistic golf course or range images. The recorded data

from the shot is then displayed with full details.

Most club fitters and big golf retailers have one. Home versions are expensive. Visiting the major club manufacturers (e.g. Titleist, Callaway, etc.) one is struck by the fact you can't get a new top-end driver for under \$600!

At this year's show I discovered several new and amazing products the first is the GolfForever at-home training system. It is mainly an asymmetrical resistance bar, complete with two handles and two exercise rubber bands, with multiple use for training and stretching. There are two carabiners to hook the bands and bar to a stationary object at the gym or at home. There is a GolfForever app which delivers to users personalized video workout plans from PGA Tour doctors and trainers.

Over 100 PGA Tour players use the GolfForever training system, including product ambassadors Zach Johnson (2023 U.S. Ryder Cup Captain) and Scotty Scheffler. Go to www.GolfForever.com. I'm not a product ambassador but I have one and really like it.



CHARLIE BLANCHARD
Golf Doctor

Then there is a product that showed up at the PGA Show almost as an accident in 2022. Mark Wolf, president of Fireside Industries, has been entrenched in the camping/outdoor world for almost a decade. He was persuaded by golfer friends to attend

the golf industries' biggest event after his company donated dozens of unique insulated drink tumblers with a built-in speaker to a local charity event. The product won the 2022 Best New Product Award. His invention is called "Vibe" and looks like an ordinary 28-ounce insulated tumbler, but features a 3.7-watt detachable Bluetooth speaker in a puck-like bottom.

To emphasize the power of the PGA Show's business impact, 12 months after winning the coveted 2022 award Wolf's Vibe Tumbler is now in more than 3,000 golf courses and resorts across the country. He now has associations

with Tito's vodka and Maker's Mark bourbon to name a few. Looking back at his product's meteoric rise, Wolf says, "to be honest, it has been pretty spectacular." You may want to go to Amazon or www.firesideoutdoor.com.

Finally, if you want to shock your friends (like I did) get ahold of a box of Mach One (single use) golf balls at www.machonegolfballs.com, the world's loudest golf ball; like a cherry-bomb.

Dr. Charlie Blanchard is a licensed psychologist specializing in sports and leadership. Contact him at docblanchard71@gmail.com.

Aggie athletics notes ...

BULLETIN REPORT

Softball: NM State will host the six-team Troy Cox Classic Feb. 24-26 at the Softball Complex. The Aggies enter the event with a 5-4 record. There will be 12 games through the weekend, with the Aggies playing in five. Friday, Feb. 24, NM State plays Nebraska at 4:30 p.m. and Creighton at 6:30 p.m. Saturday, Feb. 25, the Aggies play Oklahoma State at 11:30 a.m. and New Mexico at 2 p.m.

Sunday, Feb. 26, NM State plays the final game of the classic against Cal State-Bakersfield at 11:30 a.m.

Women's Basketball: After splitting a pair of home games last week, the Aggies are 13-14 overall and 8-7 in the Western Athletic Conference. The Aggies beat Seattle 56-47 Feb. 16, but fell 73-65 Feb. 18 to California Baptist.

NM State will play its final home game of the season, hosting UT-

Arlington at 6 p.m. Thursday, Feb. 23, at the Pan Am Center.

Baseball: Following a Feb. 24-26 road trip in Texas, the Aggies host Benedictine Mesa 6 p.m. Tuesday, Feb. 28, at Presley Askew Stadium.

The Aggies lost all three games of their opening weekend Feb. 17-19 to Belknap. The last game on Sunday, Feb. 19, was an 11-inning affair, with the Aggies falling 10-9.

NM STATE ATHLETICS

NEW MEXICO State SOFTBALL

UPCOMING

- TROY COX CLASSIC -

FRIDAY, FEB. 24 NEBRASKA vs. NM STATE • 4:30 PM
CREIGHTON vs. NM STATE • 6:30 PM

SATURDAY, FEB. 25 OSU vs. NM STATE • 11:30 AM
UNM vs. NM STATE • 2 PM

SUNDAY, FEB. 26 CSUB vs. NM STATE • 11:30 AM

NM STATE SOFTBALL COMPLEX | LAS CRUCES, NM

NEW MEXICO State BASEBALL

UPCOMING

vs. BENEDICTINE MESA

TUESDAY, FEB. 28 | 6 PM

SNUGGIE NIGHT

PRESLEY ASKEW FIELD | LAS CRUCES, NM